

# Fowler®

HIGH PRECISION



**SPECIAL EDITION**



IMTS2018

Sept. 10 - 15<sup>th</sup> • East Building • Booth #135616

# TOOL-A-THON®

Volume 18.3



**IMPORTANT**  
Due to recent tariff increases, some prices may be subject to change



valid Sept. 1<sup>st</sup> - Dec. 31<sup>st</sup>

[www.fowlerprecision.com](http://www.fowlerprecision.com)



# Bluetooth Ultra-Cal VI Electronic Calipers

**IMTS2018 Special Buy 5, Get 1 FREE!**  
Expires 9.30.18



54-100-167-0



Learn more at ...



- IP67 rated
- Available with or without Bluetooth
- Heavy duty frame
- Extra large display
- NOW available with ISO Cert.

Order No.	Description	Accuracy	Resolution	List Price	Sale Price
<b>Bluetooth</b>					
54-100-170-0	<b>NEW Buy 5 Bluetooth 6"/150mm Electronic Calipers (54-100-167-0), Get 1 FREE</b>			\$1688.05	<b>\$1475.00</b>
54-100-167-0	6"/150mm	0.0008"/20µm	0.0005"/0.01mm	\$337.61	<b>\$295.00</b>
54-100-167-C	6"/150mm <b>with ISO/A2LA Certification</b>				<b>\$324.00</b>
54-100-168-0	8"/200mm	0.0012"/30µm	0.0005"/0.01mm	626.94	<b>495.00</b>
54-100-169-0	12"/300mm	0.0012"/30µm	0.0005"/0.01mm	835.36	<b>650.00</b>
<b>Without Data Output</b>					
54-100-177-0	6"/150mm	0.0008"/20µm	0.0005"/0.01mm	\$117.30	<b>\$105.00</b>
54-100-178-0	8"/200mm	0.0012"/30µm	0.0005"/0.01mm	239.70	<b>215.00</b>
54-100-179-0	12"/300mm	0.0012"/30µm	0.0005"/0.01mm	321.30	<b>295.00</b>
<b>Accessory</b>					
54-115-246-BT	USB bluetooth receiver			\$49.25	<b>\$44.00</b>

## Ultra-Cal V Electronic Calipers

**Buy 5, Get 1 FREE!**

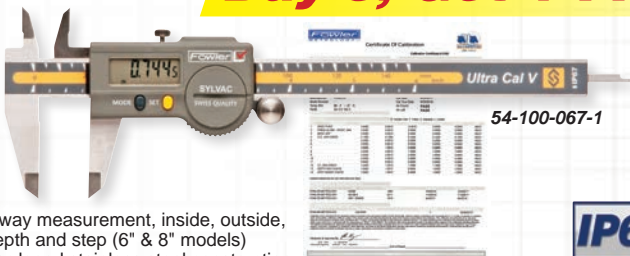

54-100-067-1



- 4-way measurement, inside, outside, depth and step (6" & 8" models)
- Hardened stainless steel construction
- Direct RS-232 output
- Features Absolute/Relative Measuring Modes
- Thumbroll (6" and 8" models only)
- NOW available with ISO Cert.

Order No.	Description	Accuracy	Resolution	List Price	Sale Price
<b>Connectivity Cables</b>					
54-100-667-0	<b>Buy 5 standard 6"/150mm Electronic Calipers (54-100-067-1), Get 1 FREE</b>			\$1012.80	<b>\$800.00</b>
54-100-067-1	6"/150mm	0.0008"/20µm	0.0005"/0.01mm	\$202.56	<b>\$160.00</b>
54-100-067-C	6"/150mm <b>with ISO/A2LA Certification</b>				<b>\$189.00</b>
54-100-068-1	8"/200mm	0.0012"/30µm	0.0005"/0.01mm	482.23	<b>365.00</b>
54-100-069-1	12"/300mm	0.0012"/30µm	0.0005"/0.01mm	578.67	<b>475.00</b>
54-115-526-0	Proximity cable with USB connection			\$138.79	<b>\$125.00</b>
54-115-527-0	Proximity cable with serial connection			138.79	<b>125.00</b>

# Ultra-Cal VI Proximity Electronic Calipers



54-100-444-1



- IP67 rated
- Ultra-Cal VI technology with proximity cable data output
- Heavy duty frame
- Extra large display

Order No.	Description	Accuracy	Resolution	List Price	Sale Price
54-100-444-1	6"/150mm	0.0008"/20µm	0.0005"/0.01mm	\$158.10	<b>\$140.00</b>
54-100-448-1	8"/200mm	0.0012"/30µm	0.0005"/0.01mm	285.60	<b>250.00</b>
54-100-412-1	12"/300mm	0.0012"/30µm	0.0005"/0.01mm	382.50	<b>350.00</b>
<b>Connectivity Cables</b>					
54-115-526-0	Proximity cable with USB connection			\$138.79	<b>\$125.00</b>
54-115-527-0	Proximity cable with serial connection			138.79	<b>125.00</b>

# Micron 0.00005" Electronic Caliper

*Absolute Reading!*



- Bluetooth connectivity
- High resolution: 0.00005"/0.001mm
- Accuracy up to 4": 0.0006"/0.015mm
- Accuracy above 4": 0.0012"/0.03mm
- Repeatability: 0.00016"/0.004mm
- Heavy duty frame (3.5mm)



Order No.	Description	List Price	Sale Price
54-100-100-0	6"/150mm Micron Electronic Caliper	\$392.23	<b>\$320.00</b>
<b>Accessory</b>			
54-115-246-BT	USB bluetooth receiver	\$49.25	<b>\$44.00</b>

Prices & Specifications are subject to change without notice.



Find us on social media!

# XTRA-VALUE Plus Electronic Calipers

INCH • METRIC • FRACTION™



- Measuring range: 6"/150mm
- Accuracy:  $\pm 0.001"/0.02\text{mm}$
- Resolution:  $0.0005"/0.01\text{mm}$
- Inch/Metric/Fraction reading:  $0.0005"/0.01\text{mm}/1/128"$
- Dust, water and oil resistant to IP54 standards making it **great for shop environments**
- Heavy Duty frame for extra rigidity and wear
- Super large, easy to read 14 x 52mm display
- Combined thumbrest and thumbroll for fine adjustment

Order No. 54-103-006-0

**Sale \$63.00** List \$77.56

# XTRA-VALUE CAL Electronic Calipers

**NEW!** Buy a 12" Get a 6" FREE

Buy a 12" (54-101-300-1) at list price and get a 6" (54-101-150-2) FREE



- Accuracy:  $0.001"/0.02\text{mm}$  (6" models)
- Stainless steel frame
- Large easy-to-read display
- Resolution:  $0.0005"/0.01\text{mm}$
- Absolute/Incremental Measurement
- 4-way measuring



Order No.	Range	Display Type	List Price	Sale Price
54-101-300-P	NEW Buy a 12" (54-101-300-1) and Get a 6" (54-101-150-2) FREE		\$149.07	<b>\$99.34</b>
54-101-150-2	6"/150mm	Regular Display - includes FREE NIST Cert.	49.73	<b>\$39.00</b>
54-101-600-1	6"/150mm	Super Large Display with hold feature	64.86	<b>\$0.00</b>
54-101-200-1	8"/200mm	Regular Display	77.80	<b>\$4.00</b>
54-101-800-1	8"/200mm	Super Large Display with hold feature	97.24	<b>\$5.00</b>
54-101-300-1	12"/300mm	Regular Display - includes FREE NIST Cert.	99.34	<b>\$2.00</b>
54-101-900-1	12"/300mm	Super Large Display with hold feature	129.84	<b>\$110.00</b>



# EURO-CAL IV® Electronic Calipers



54-100-330-1



- Absolute/Incremental Measurement
- Resolution: 0.0005"/0.01mm (Fractions in 1/64" increments)
- Stainless steel frame
- 4-way measuring

Order No.	Range	Accuracy	List Price	Sale Price
54-100-330-1	6"/150mm	± 0.001"/0.02mm	\$129.62	<b>\$95.00</b>
54-100-332-0	12"/300mm	± 0.0015"/0.03mm	196.84	<b>150.00</b>

## Water Resistant IP54 Electronic Caliper

*Absolute Reading!*



54-100-777-2 shown



- Absolute sensor technology
- 4-way measuring
- Stainless steel frame
- Resolution: 0.0005"/0.01mm



Order No.	Range	Accuracy	List Price	Sale Price
54-100-712-2	0 - 12"/300mm	0.0015"/0.04mm	\$207.52	<b>\$120.00</b>
<b>Accessory</b> 54-115-100-0	Wireless Transmitter		\$108.59	<b>\$94.00</b>

## Economy Digital Calipers

*Absolute Reading!*

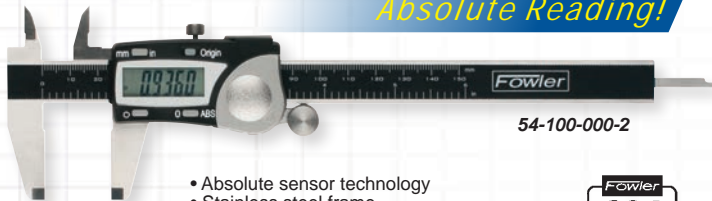

54-100-000-2

- Absolute sensor technology
- Stainless steel frame
- 4-way measuring
- Resolution: 0.0005"/0.01mm



Order No.	Range	Accuracy	List Price	Sale Price
54-100-000-2	0 - 6"/150mm Caliper	0.001"/0.02mm	\$127.03	<b>\$82.00</b>
54-100-008-2	0 - 8"/200mm Caliper	0.0015"/0.04mm	149.17	<b>110.00</b>
<b>Accessory</b> 54-115-100-0	Wireless Transmitter		\$108.59	<b>\$94.00</b>

Prices & Specifications are subject to change without notice.





# FLIP PLUS Electronic Calipers



The Flip Display allows  
**RIGHT** or **LEFT** handed operation!

54-200-506-0

- Display flips 180° with display rotation function for true left handed operation
- Can also be positioned for top viewing
- Available in 6", 8" and 12" models
- 4-way measuring - OD, ID, depth and step
- Stainless steel frame
- Thumbroll for smooth measuring
- Heavy duty frame is 0.140"/3.5mm thick
- Direct inch/metric conversion
- Resolution 0.0005"/0.01mm
- Floating zero
- Includes fitted case

**Left-Handed View****Top View**

Order No.	Range	Accuracy	List Price	Sale Price
54-200-506-0	0 - 6"/150mm	± 0.0012"/0.03mm	\$91.75	<b>\$80.00</b>
54-200-508-0	0 - 8"/200mm	± 0.0012"/0.03mm	112.15	<b>99.00</b>
54-200-512-0	0 - 12"/300mm	± 0.0016"/0.04mm	142.75	<b>125.00</b>

## Caliper Jaw Attachments

*Contacts sold separately!*



- Clamps on to caliper jaws, allows attachment of standard micrometer anvils
- Used alone or in pairs
- Contacts can be mixed or offset for unique applications
- Max. caliper jaw thickness 0.135"
- Made of stainless steel



*Caliper shown not included*



52-249-010-0

Order No.	Description	List Price	Sale Price
52-249-010-0	Caliper Jaw Attachment	\$41.62	<b>\$37.00</b>
52-249-001-0	Spline: 0.100" dia.	19.78	<b>16.00</b>
52-249-002-0	Knife: 0.188" x 0.031" tip, 30° taper	19.78	<b>16.00</b>
52-249-003-0	Super Spline: 0.050" dia.	19.78	<b>16.00</b>
52-249-004-0	Blade: 0.188" x 0.031"	19.78	<b>16.00</b>
52-249-005-0	Point: 0.020" tip, 30° taper	19.78	<b>16.00</b>
52-249-006-0	Disc: 0.500" dia.	23.49	<b>16.00</b>
52-249-007-0	Complete 7 piece Contact Set, includes 1 Ball Contact	69.26	<b>55.00</b>

# Light Line Electronic Calipers



54-112-012-0

- Light weight beam made of oxide coated aluminum with double inner prismatic guide ways for optimal guidance and sliding characteristics
- Stainless steel jaws, hardened and finely ground with knife edge top jaws
- Jaws are adjustable and exchangeable
- Spare jaws can be modified and exchanged with standard jaws for special applications
- Both jaws are moveable to any position on the main beam
- Electronics feature on/off, floating zero and direct in/mm conversion
- 0.0005"/.01mm resolution and repeatability
- Includes a fitted case, instructions and test certificate

Order No.	Range	Accuracy	List Price	Sale Price
54-112-012-0	0 - 12"/300mm	0.0015"/0.04mm	\$306.92	<b>\$255.00</b>
54-112-030-0	0 - 31"/800mm	0.002"/0.06mm	707.47	<b>600.00</b>
<b>Accessory</b> 52-075-150-0	6" replacement jaws		\$104.04	<b>\$90.00</b>

# XTRA-RANGE® Electronic Calipers

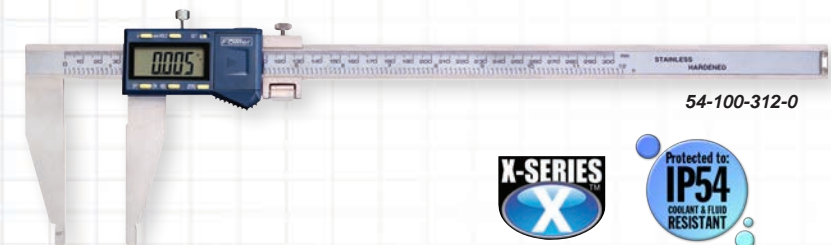

54-100-312-0



**Shop-Hardened Case!**

- Hold feature
- Absolute/Incremental measurement
- Preset mode includes offset size for ID measurements
- All sizes feature fine adjustment screw
- Resolution: 0.0005"/0.01mm

Order No.	Range	Jaw Depth	Accuracy	List Price	Sale Price
54-100-312-0	0 - 12"/300mm	3.5"	0.002"/0.04mm	\$224.38	<b>\$164.00</b>
54-100-024-1	0 - 24"/600mm	4"	0.003"/0.08mm	326.79	<b>270.00</b>
<b>Accessory</b> 54-115-781-0	Xtra-Range SPC cable			\$98.25	<b>\$85.00</b>

Prices & Specifications are subject to change without notice.



# Fowler-Sylvac Ultralight IV Electronic Calipers

The Fowler-Sylvac Ultralight IV, new design, new features, built-in Bluetooth transmitter. Discover our amazing Ultralight long range calipers.

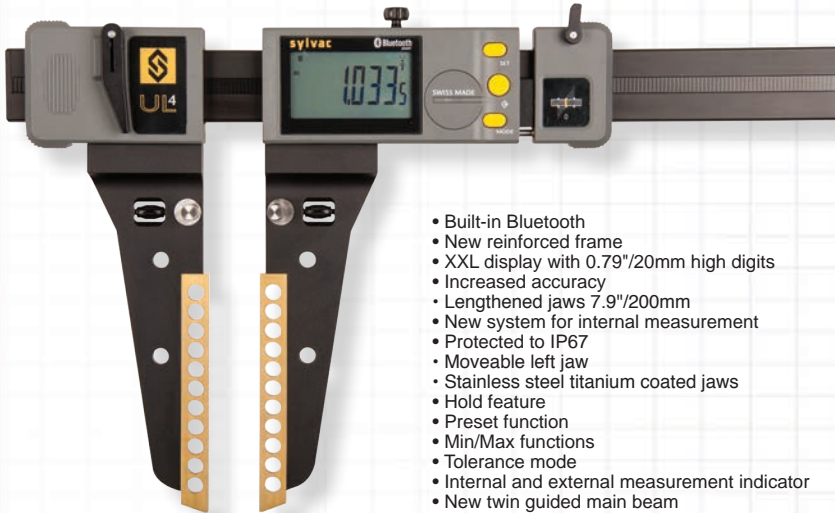

- Built-in Bluetooth
- New reinforced frame
- XXL display with 0.79"/20mm high digits
- Increased accuracy
- Lengthened jaws 7.9"/200mm
- New system for internal measurement
- Protected to IP67
- Moveable left jaw
- Stainless steel titanium coated jaws
- Hold feature
- Preset function
- Min/Max functions
- Tolerance mode
- Internal and external measurement indicator
- New twin guided main beam



Fowler® TOOL-A-THON® Vol. 18.3



Alternative jaws available, contact the Fowler Technical Department for more information 1-800-788-2353

Specifications	54-110-512-0	54-110-524-0	54-110-540-0	54-110-560-0	54-110-580-0	54-110-600-0
Measuring Range	0-15"/0-400mm	0-24"/0-600mm	0-40"/0-1000mm	0-60"/0-1500mm	0-80"/0-2000mm	0-100"/0-2500mm
Maximum Error	30µm/0.0012"	40µm/0.0016"	50µm/0.002"	90µm/0.0035"	120µm/0.0048"	200µm/0.0078"
Repeatability	20µm/0.0008"				30µm/0.0012"	
Measuring Force	5 - 10 N					
Connection	Bluetooth Smart/Proxi. - RS-232 or - USB					
Protection Rating	IP67 (Electronic Module)					
Preset Max.	±9999.99 mm / ±399.9995 IN					
Weight	1.5 kg	1.6 kg	1.9 kg	2.3 kg	2.6 kg	2.9 kg

Order No.	Description	List Price	Sale Price
54-110-512-0	0 - 15"/0 - 400mm Ultralight IV	\$2061.42	<b>\$1810.00</b>
54-110-524-0	0 - 24"/0 - 600mm Ultralight IV	2406.18	<b>2155.00</b>
54-110-540-0	0 - 40"/0 - 1000mm Ultralight IV	2769.30	<b>2515.00</b>
54-110-560-0	0 - 60"/0 - 1500mm Ultralight IV	4163.64	<b>3760.00</b>
54-110-580-0	0 - 80"/0 - 2000mm Ultralight IV - <i>special order</i>	5736.48	<b>5150.00</b>
54-110-600-0	0 - 100"/0 - 2500mm Ultralight IV - <i>special order</i>	6931.92	<b>6400.00</b>
<b>Connectivity Cables/Accessory</b>			
54-115-526-0	Proximity USB Cable	\$138.79	<b>\$125.00</b>
54-115-527-0	Proximity Serial Cable	136.79	<b>125.00</b>
54-115-246-BT	USB Bluetooth Receiver	49.25	<b>44.00</b>



# Machinist Grade Dial Calipers



52-008-706-0



52-008-707-0



52-008-709-0

- 4-way measuring
- Solid stainless steel construction
- 0.100"/2mm range per revolution
- 0.001"/0.02mm reading dial face
- Tough shockproof gearing

Order No.	Range	Dial Face Color	Accuracy	List Price	Sale Price
52-008-706-0	0 - 6"	White	± 0.001"	\$80.00	<b>\$60.00</b>
52-008-707-0	0 - 6"	Black	± 0.001"	80.00	<b>60.00</b>
52-008-708-0	0 - 8"	White	± 0.0015"	97.62	<b>78.00</b>
52-008-709-0	0 - 150mm (Metric Model)	Yellow	± 0.02mm	80.00	<b>60.00</b>

## 0 - 6" Dial Calipers

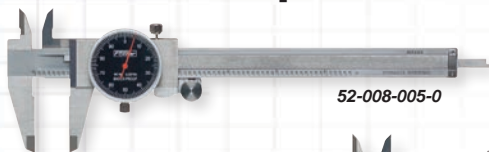

52-008-005-0

- 4-way measuring
- Covered rack
- Accuracy ± 0.001"
- 0.100" per revolution
- Dial graduation: 0.001"
- Hardened stainless steel rack



52-008-007-0

Order No.	Range	Dial Face Color	Accuracy	List Price	Sale Price
52-008-005-0	0 - 6"/150mm	Black	± 0.001"	\$91.50	<b>\$59.00</b>
52-008-007-0	0 - 6"/150mm	White	± 0.001"	85.00	<b>59.00</b>

## Extended Range Dial Caliper



- Measuring range: 18"
- Depth of jaws: 3.125"
- Graduations: 0.001"
- Stainless steel construction
- Satin chrome finish
- Depth rod
- 0.500" internal measuring nibs

Order No. 52-008-018-0

**Sale \$155.00**

List \$257.08

Fowler TOOL-A-THON® Vol. 18.3



Find us on social media!

# Outside Inch Micrometers



52-240-001-1



52-215-003-1

- Microfine graduations on satin chrome finish and carbide tipped measuring faces
- Diameter of measuring faces: 0.256"
- Graduation: 0.0001"
- Flatness: 0.00003"
- Positive lever locking clamp
- Spindle thread hardened, ground and lapped for ultimate accuracy
- Anvil & spindle hardened and precision ground with microlap finish on tips
- Includes a wrench and case

Order No.	Range	Accuracy	Thimble	List Price	Sale Price
52-240-001-1	0 - 1"	± 0.00015"	Friction	\$41.60	<b>\$33.00</b>
52-240-101-1	0 - 1"	± 0.00015"	Ratchet	41.60	<b>33.00</b>
52-240-002-1	1 - 2"	± 0.00015"	Friction	48.36	<b>38.00</b>
52-240-102-1	1 - 2"	± 0.00015"	Ratchet	48.36	<b>38.00</b>
52-240-003-1	2 - 3"	± 0.0002"	Ratchet	56.52	<b>45.00</b>
52-240-004-1	3 - 4"	± 0.0002"	Ratchet	63.15	<b>50.00</b>
52-240-005-1	4 - 5"	± 0.00025"	Ratchet	69.91	<b>55.00</b>
52-240-006-1	5 - 6"	± 0.00025"	Ratchet	76.67	<b>61.00</b>
52-240-007-1	6 - 7"	± 0.0003"	Ratchet	83.31	<b>66.00</b>
52-240-008-1	7 - 8"	± 0.0003"	Ratchet	98.11	<b>78.00</b>
52-240-009-1	8 - 9"	± 0.0003"	Ratchet	111.51	<b>89.00</b>
52-240-010-1	9 - 10"	± 0.0003"	Ratchet	126.43	<b>101.00</b>
52-240-011-1	10 - 11"	± 0.00035"	Ratchet	139.83	<b>111.00</b>
52-240-012-1	11 - 12"	± 0.00035"	Ratchet	153.23	<b>122.00</b>
<b>Sets</b>					
52-215-003-1	0 - 3" with standards and fitted shop hardened case			\$180.03	<b>\$130.00</b>
52-215-004-1	0 - 4" with standards and fitted shop hardened case			231.18	<b>170.00</b>
52-215-006-1	0 - 6" with standards and fitted wooden case			356.23	<b>265.00</b>
52-215-612-1	6 - 12" with standards and fitted wooden case			733.88	<b>560.00</b>

# Outside Inch Micrometers

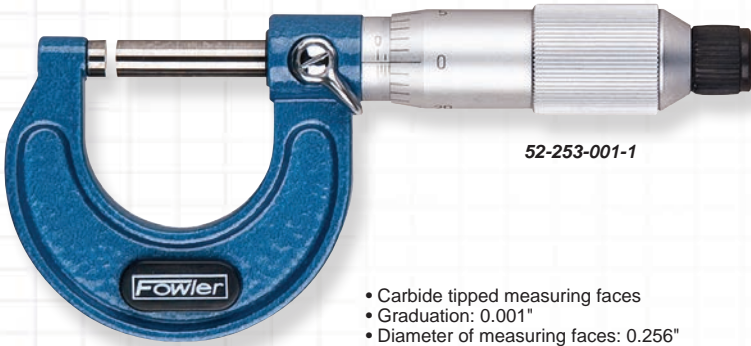

52-253-001-1

- Carbide tipped measuring faces
- Graduation: 0.001"
- Diameter of measuring faces: 0.256"
- Positive locking lever
- Anvil & spindle hardened and precision ground with microlap finish on tips
- Includes standard with sizes 2" and over

Order No.	Range	Accuracy	Thimble	List Price	Sale Price
52-253-001-1	0 - 1"	± 0.001"	Friction	\$34.96	<b>\$28.00</b>
52-253-101-1	0 - 1"	± 0.001"	Ratchet	34.96	<b>28.00</b>
52-253-102-1	1 - 2"	± 0.001"	Ratchet	41.60	<b>33.00</b>
52-253-003-1	2 - 3"	± 0.001"	Ratchet	48.36	<b>38.00</b>
52-253-004-1	3 - 4"	± 0.001"	Ratchet	56.52	<b>45.00</b>
52-253-005-1	4 - 5"	± 0.001"	Ratchet	63.15	<b>50.00</b>
52-253-006-1	5 - 6"	± 0.001"	Ratchet	69.91	<b>56.00</b>
<b>Set</b>					
52-253-600-1	0 - 6"			\$321.26	<b>\$250.00</b>

# Outside Inch Micrometers

*with Decimal Equivalents on Frame*



52-235-001-1

- Black decimal equivalents on satin chrome finished forged steel frame
- Graduations: 0.0001"
- Ratchet thimble and locking nut
- Includes standard for 1-2" sizes

Order No.	Range	Accuracy	Thimble	List Price	Sale Price
52-235-001-1	0 - 1"	± 0.0001"	Ratchet	\$66.24	<b>\$49.00</b>
52-235-002-2	1 - 2"	± 0.0001"	Ratchet	76.67	<b>57.00</b>
52-235-003-2	2 - 3"	± 0.0001"	Ratchet	95.84	<b>71.00</b>
<b>Set</b>					
52-235-100-0	0 - 3"			\$240.24	<b>\$214.00</b>



## Digit Counter Micrometers



52-224-001-0

"Perfect"  
J.J



52-224-103-0

- Digital counter reads to 0.001"
- Resolution: 0.0001" (using vernier)
- Microfine graduations on satin chrome
- Carbide tipped measuring faces
- Positive locking nut on spindle
- Sizes over 1" include standard
- Includes case

Order No.	Range	List Price	Sale Price
52-224-001-0	0 - 1"	\$113.74	<b>\$79.00</b>
52-224-002-0	1 - 2"	119.48	<b>83.00</b>
52-224-003-0	2 - 3"	136.09	<b>95.00</b>
52-224-004-0	3 - 4"	149.70	<b>104.00</b>
52-224-005-0	4 - 5"	158.44	<b>110.00</b>
52-224-006-0	5 - 6"	165.67	<b>116.00</b>
<b>Sets</b>			
52-224-103-0	0 - 3" set	\$359.04	<b>\$251.00</b>
52-224-104-0	0 - 4" set	509.13	<b>356.00</b>
52-224-220-0	0 - 75mm set	378.04	<b>264.00</b>

## Swiss-Style Micrometers



52-229-201-0

"Awesome set of mics!"  
Erik

Check us out!  
**YouTube**  
**FowlerVid**



52-229-213-0

- 0.0001" reading
- Carbide measuring faces
- Insulated frame
- Ratchet thimble and locking lever
- Microfine graduations
- Sizes over 1" include standard
- Includes case

Order No.	Range	Accuracy	List Price	Sale Price
52-229-201-0	0 - 1"	± 0.00016"	\$53.87	<b>\$40.00</b>
52-229-202-0	1 - 2"	± 0.00016"	63.09	<b>47.00</b>
52-229-203-0	2 - 3"	± 0.0002"	77.78	<b>58.00</b>
52-229-204-0	3 - 4"	± 0.0002"	89.29	<b>66.00</b>
52-229-205-0	4 - 5"	± 0.00024"	110.27	<b>82.00</b>
52-229-206-0	5 - 6"	± 0.00024"	129.52	<b>97.00</b>
<b>Sets</b>				
52-229-213-0	0 - 3"		\$194.21	<b>\$145.00</b>
52-229-214-0	0 - 4"		274.95	<b>206.00</b>
52-229-220-0	0 - 100mm		274.95	<b>206.00</b>



# Vernier Thread Micrometers



52-219-001-1

**NEW!**

- 60° measuring anvils
- Painted enamel and heat insulated frame
- Positive spindle lock
- Graduation: 0.001"
- Ratchet thimble
- Sizes over 1" include standard

Order No.	Range	Thread Range	Accuracy	List Price	Sale Price
52-219-001-1	<b>NEW</b> 0 - 1"	64 - 5 TPI/0.4 - 5mm	0.00016"	\$81.60	<b>\$73.00</b>
52-219-002-1	<b>NEW</b> 1 - 2"	44 - 3.5 TPI/0.6 - 7mm	0.00016"	91.80	<b>82.00</b>
52-219-003-1	<b>NEW</b> 2 - 3"	24 - 3.5 TPI/1 - 7mm	0.0002"	107.10	<b>95.00</b>
52-219-004-1	<b>NEW</b> 3 - 4"	24 - 3.5 TPI/1 - 7mm	0.0002"	117.30	<b>103.00</b>

# Interchangeable Anvil Micrometers

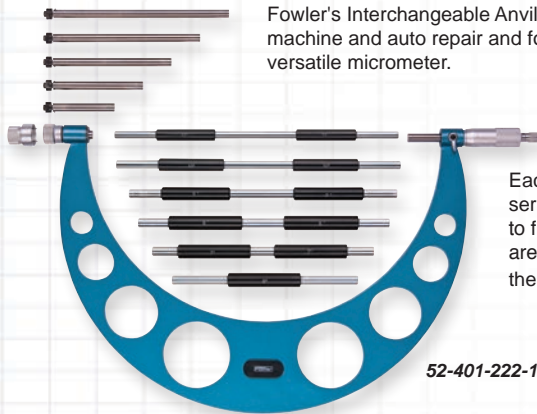

52-401-222-1

Fowler's Interchangeable Anvil Micrometers are very popular in machine and auto repair and for all other applications requiring a versatile micrometer.

Each micrometer is equipped with a series of easily interchangeable anvils to fulfill the ranges listed. Standards are also included to accurately adjust the required range.

- Hammetone blue baked enamel frame
- Graduations are microfine on satin chrome for easy reading
- Each anvil is fitted with an adjusting collar to set the overall dimension
- Spindle thread is hardened and precision ground with microlap finish in carbide tipped measuring faces
- Ratchet stop ensures exact readings
- A wrench is included for fast, easy zero adjustment on the sleeve
- Positive lever locking clamp assures accurate settings
- Standards are included with each set
- Parallelism: 0.0004"
- Flatness: 0.00003"

Order No.	Range	Graduation	Accuracy	List Price	Sale Price
52-401-221-1	0 - 6"	0.0001"	0.00024"	\$254.94	<b>\$185.00</b>
52-401-222-1	6 - 12"	0.0001"	0.00024"	374.42	<b>269.00</b>
52-401-204-1	12 - 16"	0.001"	0.00036"	449.33	<b>320.00</b>



# Rapid-Mic Quick-Displacement Electronic Micrometers



54-815-030-0

**WORLD'S FINEST  
Micrometer!**

**NOW  
available with  
ISO Cert.**

“ I have been in the machining business for over 30 years this is by far the best mic I have ever had. One little thing or should I rephrase that, one huge thing, this mic comes with a lifetime warranty... no other company can provide that! ”

John T.

## NEW Bluetooth Ranges NOW Available!

- Position recall
- Delrin quick displacement thimble
- Adjustable measuring force, 5N/10N (54-815-030-0 only)
- Menu customizable with free software
- Non-rotating spindle, 10mm/spindle rotation
- USB output or bluetooth available



54-815-111-0

**LIFETIME WARRANTY**



Watch the Demo!

**YouTube  
FowlerVid**

Order No.	Description	Max Error	List Price	Sale Price
54-815-030-0	0 - 1.18"/0 - 30mm	0.00012"/0.003mm	\$525.09	<b>\$435.00</b>
54-815-030-C	1.18"/30mm <b>with ISO/A2LA Certification</b>			<b>460.00</b>
54-815-060-0	1.18" - 2.6"/30 - 66mm	0.00016"/0.004mm	776.97	<b>710.00</b>
54-815-100-0	2.6" - 4.0"/66 - 102mm	0.00020"/0.005mm	1086.60	<b>960.00</b>
<b>Set</b>				
54-815-111-0	0 - 4"/0 - 102mm		\$2369.46	<b>\$1995.00</b>
<b>Bluetooth Models</b>				
54-815-130-0	0 - 1.18"/0 - 30mm	0.00012"/0.003mm	\$776.97	<b>\$669.00</b>
54-815-160-0	<b>NEW</b> 1.18" - 2.6"/30 - 66mm	0.00016"/0.004mm	1028.16	<b>955.00</b>
54-815-110-0	<b>NEW</b> 2.6" - 4.0"/66 - 102mm	0.00020"/0.005mm	1338.24	<b>1199.00</b>
<b>Bluetooth Set</b>				
54-815-112-0	<b>NEW</b> 0 - 4"/0 - 102mm		\$2938.62	<b>\$2499.00</b>
<b>Connectivity Cables/Accessory</b>				
54-115-526-0	Proximity cable with USB connection		\$138.79	<b>\$125.00</b>
54-115-527-0	Proximity cable with serial connection		138.79	<b>125.00</b>
54-115-246-BT	USB Bluetooth receiver		49.25	<b>44.00</b>

# XTRA-VALUE II Electronic Micrometers



54-870-001-0



- Resolution: 0.00005"/0.001mm
- Accuracy:  $\pm 0.00016"/0.004\text{mm}$  (up to 2")
- Carbide measuring faces
- Absolute and incremental modes
- Ratchet thimble

Order No.	Range	List Price	Sale Price
54-870-001-0	0 - 1"/0 - 25mm	\$97.24	<b>\$72.00</b>
54-870-002-0	1 - 2"/25 - 50mm	105.00	<b>79.00</b>
54-870-003-0	2 - 3"/50 - 75mm	119.00	<b>88.00</b>
54-870-004-0	3 - 4"/75 - 100mm	133.00	<b>99.00</b>
54-870-103-0	0 - 3"/0 - 75mm Set	286.54	<b>210.00</b>
Accessory			
54-115-779-0	SPC Cable	\$133.55	<b>\$99.00</b>

## Electronic Coolant Resistant Micrometers



54-860-001-1



- Protected to IP54 specifications
- Automatic switch off
- Accuracy:  $\pm 0.00016"/0.004\text{mm}$  (up to 2")
- Resolution: 0.00005"/0.001mm
- Carbide measuring faces
- Absolute & incremental modes

Order No.	Range	List Price	Sale Price
54-860-001-1	0 - 1"/0 - 25mm	\$123.21	<b>\$95.00</b>
54-860-002-1	1 - 2"/25 - 50mm	142.65	<b>109.00</b>
Set			
54-860-103-1	0 - 3"/0 - 75mm Set	\$405.26	<b>\$305.00</b>
Accessory			
54-115-779-0	SPC Cable	\$133.55	<b>\$99.00</b>

Fowler® TOOL-A-THON® Vol. 18.3



Find us on social media!





# XTRA-VALUE Digi-Micrometer



54-815-001-2

- Range: 0 - 1"/25mm
- Rugged steel design
- Large LCD Display
- Absolute & incremental modes
- Automatic switch off
- Resolution: 0.00005"/.001mm
- Direct RS232 output
- Carbide measuring faces



Order No. 54-815-001-2

**Sale \$120.00** List \$162.11

## QuadraMic Electronic 4-way Reading Micrometers



54-866-001-0

**Micrometer reads 4 ways for incredible versatility!**



Features two displays which enable the operator to read as a right or left-handed micrometer. Simply press a button to invert the display allowing the micrometer to be used for a variety of measuring positions.

- Large 4-way reading LCD display
- Automatic switch off
- Absolute measuring system
- Resolution: 0.00005"/0.001mm
- Friction thimble
- Direct RS 232 output
- Carbide measuring faces
- Includes case

Order No.	Range	Accuracy	List Price	Sale Price
54-866-001-0	0 - 1.2"/0 - 30mm	± 0.00016"/0.004mm	\$198.39	<b>\$170.00</b>
54-866-002-0	1 - 2.2"/25 - 55mm	± 0.00016"/0.004mm	258.28	<b>220.00</b>
54-866-003-0	2 - 3.2"/50 - 80mm	± 0.0002"/0.005mm	297.76	<b>255.00</b>
54-866-004-0	3 - 4.2"/75 - 100mm	± 0.0002"/0.005mm	330.74	<b>280.00</b>



## Digit Counter Ball-Anvil Micrometers



52-244-201-1

- Microfine graduations on satin chrome.
- Digital counter reads to 0.001"; sleeve reads to 0.0001"
- No. 52-244-201-1 spindle hardened and precision ground with a carbide tipped measuring face
- No. 52-244-301-1 anvil is hardened and precision ground
- Spindle thread hardened, ground & lapped
- Ratchet stop thimble on all models
- Accuracy: 0.00016"
- Graduation: 0.0001"

Order No.	Range	List Price	Sale Price
52-244-201-1	0 - 1" Ball Anvil	\$119.48	<b>\$89.00</b>
52-244-301-1	0 - 1" Ball Anvil & Spindle	126.72	<b>95.00</b>

## Digit Counter Disc Micrometer



- Measuring range: 0 - 1"
- Anvil and spindle are hardened and precision ground with microlap finish on measuring faces
- Quick and easy zero adjustment on sleeve.
- Flatness: 0.00004"
- Accuracy: 0.00016", Graduation: 0.0001"
- Disc edge thickness: 0.035", Disc dia.: 0.708"
- Center opening: 0.280"
- Ratchet thimble
- The disc type anvil and spindle simplifies measuring the thickness of difficult, closely spaced sections, ribs, keys, fins, cutting edges on forming tools, chordal thickness of gear teeth, etc.

Order No. 52-250-301-1

**Sale \$120.00**

List \$157.06

## Digit Counter Point Micrometer



- Measuring range:
- Anvil and spindle are carbide tipped and precision ground with microlap finish on ends
- Microfine graduations 0.0001"/0.001mm on satin chrome finish for easy reading
- Spindle thread hardened, ground & lapped
- Quick, easy zero adjustment on sleeve
- The radius of the measuring points is approximately 0.012"
- Features ratchet stop
- Accuracy: 0.00016"

Order No. 52-226-801-1

**Sale \$145.00**

List \$217.48



## Inside Micrometers

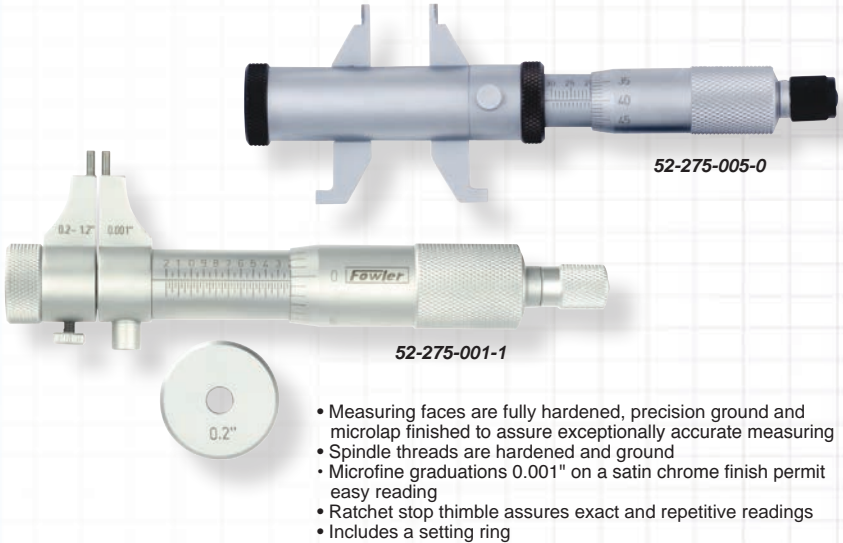

- Measuring faces are fully hardened, precision ground and microlap finished to assure exceptionally accurate measuring
- Spindle threads are hardened and ground
- Microfine graduations 0.001" on a satin chrome finish permit easy reading
- Ratchet stop thimble assures exact and repetitive readings
- Includes a setting ring

Order No.	Range	Graduation	Accuracy	List Price	Sale Price
52-275-001-1	0.2" - 1.2"	0.001"	0.0002"	\$113.74	<b>\$85.00</b>
52-275-005-0	0.2" - 2.2"	0.001"	0.0002"	192.27	<b>155.00</b>

## Micrometer Stands

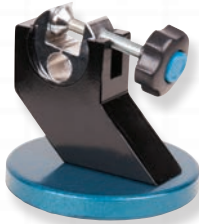

- 52-247-000-0**
- Provides a measuring position and angle for outside micrometers and other instruments



**52-247-005-0**

- Unique locking nut adjusts micrometer stand to any position for perfect use and viewing
- Stand folds for storage



- 52-247-010-0**
- Micrometer not included*
- Holds standard 0-12" micrometers firmly to metal surfaces
  - Use at machine centers, work, assembly and inspection stations, steel tables and shelves
  - V-bottom for mounting on cylindrical surfaces
  - On/Off magnet switch
  - Base is 2.30" L x 1.20" W x 3.50" H

Order No.	Description	List Price	Sale Price
52-247-000-0	Adjustable Micrometer Stand	\$59.20	<b>\$45.00</b>
52-247-005-0	Folding Micrometer Stand	39.62	<b>31.00</b>
52-247-010-0	Magnetic Micrometer Stand	53.06	<b>42.00</b>

# Premium Depth Micrometers

- Clear microfine graduations on satin chrome finish
- Base constructed of hardened tool steel is precision ground and microlapped. All other surfaces are satin chrome finished.
- Quick and easy zero adjustment
- Rods hardened, ground and lapped on measuring surfaces and adjustable in either direction
- Interchangeable rods are fitted to the micrometer spindle against a positive stop and locked
- Ratchet thimble
- Threads hardened, ground and lapped for accuracy
- Price includes spanner wrench and fitted case

52-225-005-1

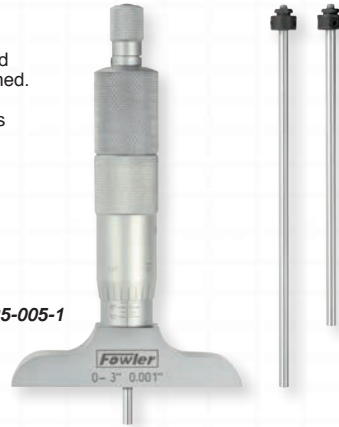

Order No.	Range	Graduation	Accuracy	Base Size	List Price	Sale Price
52-225-005-1	0 - 3"	0.001"	0.0002"	2.5"	\$161.27	<b>\$129.00</b>
52-225-006-1	0 - 4"	0.001"	0.0002"	2.5"	193.55	<b>153.00</b>
52-225-011-1	0 - 4"	0.001"	0.0002"	4"	193.55	<b>153.00</b>
52-225-015-1	0 - 6"	0.001"	0.0002"	4"	220.46	<b>170.00</b>
52-225-020-1	0 - 6"	0.001"	0.0002"	2.5"	212.43	<b>165.00</b>
52-225-030-1	0 - 12"	0.001"	0.00028"	2.5"	329.30	<b>260.00</b>
52-225-035-1	0 - 12"	0.001"	0.00028"	4"	344.10	<b>270.00</b>

# Economy Depth Micrometers



52-225-116-0

- Satin chrome finish
- Base surface hardened and ground
- Ratchet thimble
- Locking clamp
- Rod diameter: 0.176"
- Includes case

Order No.	Range	Graduation	Accuracy	Base Size	List Price	Sale Price
52-225-112-0	0 - 6"	0.001"	0.0002"	2.5"	\$159.63	<b>\$135.00</b>
52-225-114-0	0 - 4"	0.001"	0.0002"	4"	146.01	<b>125.00</b>
52-225-116-0	0 - 6"	0.001"	0.0002"	4"	170.85	<b>143.00</b>





## X-DEPTH 22<sup>®</sup> 0 - 22"/558mm Depth Gauge

*Inch & Metric Reading*

**NEW!**

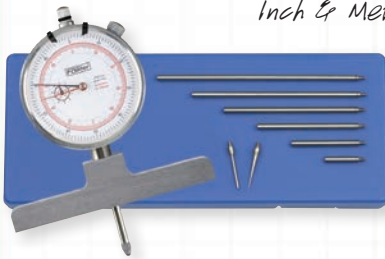

- 0 - 1<sup>1</sup>/<sub>0</sub> - 25mm travel indicator
- 0.001"/0.01mm graduations
- Rods connect together for full 22"/558mm capacity
- Satin chrome finish
- Base size: 4"
- Includes 2 extra points for small hole applications; one 0.078" dia. x 1" long and one needle point x 1" long

Order No. 52-125-008-0



**Sale \$185.00**

List \$215.00

## X-DEPTH 22<sup>®</sup> 0 - 22" Depth Gauge

*Twice the range of competitive products!*

- 0 - 1" travel indicator
- 0.001" Graduations
- Rods connect together for full 22" capacity
- Satin chrome finish
- Base size: 4"
- Includes 2 extra points for small hole applications; one 0.078" dia. x 1" long and one needle point x 1" long

*"Works like a charm!"*

S.M

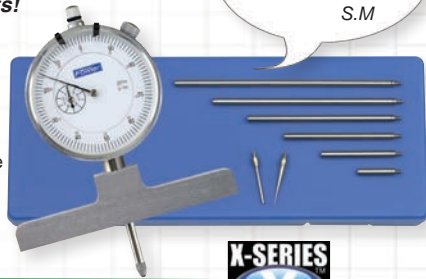

Order No. 52-125-006-1



**Sale \$135.00**

List \$197.17



## X-DEPTH 22<sup>®</sup> 0 - 22" Electronic Depth Gauge



- 0 - 1" travel electronic indicator
- Zero reset at any position
- On/off button
- Relative/absolute measuring
- Bottom surface of the base is hardened, ground & lapped
- Full 22" range
- Resolution .0005"/.01mm
- Hold feature
- 4" Base
- Includes 2 extra points for small hole applications; one 0.078" dia. x 1" long and one needle point x 1" long

Order No. 54-125-777-0



**Sale \$205.00**

List \$265.75



## Light-Line Digital Depth Gages

- Light weight beam made of oxide coated aluminum with double inner prismatic guide ways
- Bases made of hard anodized aluminum
- Includes three base attachments: 150/300/450mm
- Includes two contact points
- Electronics feature on/off, floating zero and direct in/mm conversion
- 0.0005"/0.01mm resolution and repeatability
- Includes a fitted case, instructions, 2 spare base screws, 2 hex wrenches and test certificate.



54-136-012-0

Order No.	Range	Accuracy	List Price	Sale Price
54-136-012-0	0 - 12"/300mm	0.0015"/0.04mm	\$478.58	<b>\$400.00</b>
54-136-030-0	0 - 31"/800mm	0.0024"/0.06mm	811.51	<b>710.00</b>

## Toolmaker Universal Measuring Set



- 6" Dial Caliper - .001" graduations  
(Part No. 52-008-007-0 see page 9)
- 0-1" Micrometer - .0001" graduations  
(Part No. 52-229-201-0 see page 12)
- 6" Flexible rule with 32nds, 64ths, 10ths & 100ths graduations

Order No. 52-095-007-0

**Sale \$125.00**

List \$166.40

## Blackface Measuring Set



- 0 - 6" Machinist Grade Caliper 52-008-707-0: .001" Graduations, 0.100" range/rev., Thumbroll, 4-way measuring.
- 0 - 1" Outside Micrometer 52-229-201-0: 0.0001" Graduations, Carbide tipped measuring faces, Insulated frame
- Test Indicator: 52-562-778-0: 0.030" range, 0.0005" graduations, 2 dovetail stems and 3 contact points; 0.040", 0.080" & 0.120"
- Complete in shop-hardened case

Order No. 52-229-770-0

**Sale \$235.00**

List \$312.90

Fowler® TOOL-A-THON® Vol. 18.3



Find us on social media!

# Fowler-Bowers Universal Gage Set

## Internal & External Measurements up to 118"

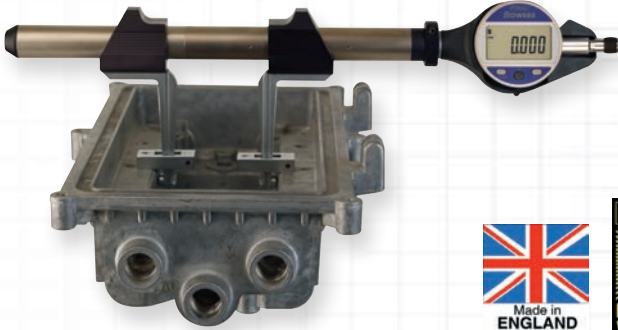

- Internal and external measurement
- Extremely large measuring range 0 - 118" / 0 - 3000mm
- Large range of accessories with constant measuring pressure and digital readout
- Stackable extensions for increasing range
- Anvil travel of 0.590"/15mm

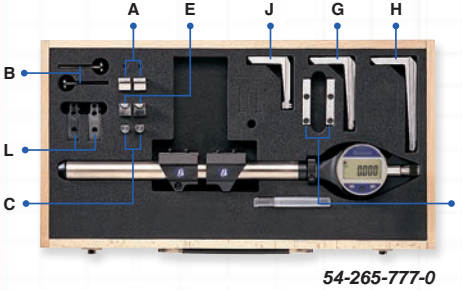

54-265-777-0

### Accessories

A.	54-265-045-0	Pair of Flat Shoulder Anvils
B.	54-265-048-0	Pair of Internal Disc Anvils (large)
C.	54-265-049-0	Pair of Internal/External Disc Anvils (small)
D.	54-265-055-0	Pair of Clamping adaptors
E.	54-265-047-0	Pair of Cylindrical Shoulder Anvils
F.	54-265-015-0	Pair of Spherical Tip Contact Points
G.	54-265-030-0	Pair of Measuring Arms 3"/75mm long
H.	54-265-040-0	Pair of Measuring Arms 4"/100mm long
I.	54-265-043-0	Pair of Depth Stops
J.	54-265-020-0	Pair of Measuring Arms 2"/50mm long
K.	54-265-010-0	Pair of Flat Contact Points
L.	54-265-041-0	Pair of Mounting attachments

### Available on special order

Pair of ball inserts for gear/spline measurements. Thread inserts for internal/external threads. Special anvils such as cones, balls, pins, etc. Contact our Technical Department for price quotes.

Order No.	Description	List Price	Sale Price
54-265-777-0	Universal Gage Set with digital readout and accessories listed above Internal Range 1.18 - 10"/30 - 250mm External Range 0 - 8.4"/0 - 215mm	\$7165.50	<b>\$6450.00</b>
<b>Accessories</b>			
54-265-000-0	Universal Gage Only with Indicator	\$3600.00	<b>\$3100.00</b>
54-265-001-0	Universal Gage Only No Indicator	2770.20	<b>2300.00</b>
54-265-090-0	6" extension: Increases range of universal gage by 6"/150mm	316.20	<b>260.00</b>
54-265-100-0	20" extension: Increases range of universal gage by 20"/500mm	969.00	<b>800.00</b>
54-265-010-0	Pair of Flat Contact Points	109.34	<b>90.00</b>
54-265-015-0	Pair of Spherical Tip Contact Points	109.34	<b>90.00</b>
54-265-020-0	Pair of Measuring Arms 2"/50mm long	522.90	<b>434.00</b>
54-265-030-0	Pair of Measuring Arms 3"/75mm long	542.25	<b>450.00</b>
54-265-040-0	Pair of Measuring Arms 4"/100mm long	633.29	<b>525.00</b>
54-265-041-0	Pair of Mounting attachments	590.43	<b>490.00</b>
54-265-043-0	Pair of Depth Stops	365.38	<b>300.00</b>
54-265-045-0	Pair of Flat Shoulder Anvils	468.28	<b>385.00</b>
54-265-047-0	Pair of Cylindrical Shoulder Anvils	468.28	<b>385.00</b>
54-265-048-0	Pair of Internal Disc Anvils (large)	291.52	<b>240.00</b>
54-265-049-0	Pair of Internal/External Disc Anvils (small)	291.52	<b>240.00</b>
54-265-055-0	Pair of Clamping adaptors	57.84	<b>45.00</b>

# Fowler-Bowers XT-Series Holemikes



**SPECIAL DEAL!**



**FREE**

Free 6" IP54  
Electronic Caliper  
with Holemike purchase!  
\$142.00 Value

The Fowler-Bowers range of mechanical two and three point bore micrometers are now available as XT extended travel holemikes, allowing a wide measurement range without the need to interchange anvils.



- 3-pt contact with tungsten carbide measuring anvils above 0.5"
- Blind bore measuring heads featured above 0.5"
- Ratchet stop for consistent measuring
- Extensions available for deep measuring
- Includes UKAS certificates for all Holemikes and setting rings

Order No.	Range	Grads.	Accuracy	Meas. Depth	Ring Included	List Price	Sale Price
52-255-310-0	0.250" - 0.312"	0.00025"	0.00015"	2.28"	0.312"	\$723.39	<b>\$560.00</b>
52-255-311-0	0.312" - 0.375"	0.00025"	0.00015"	2.28"	0.312"	669.81	<b>520.00</b>
52-255-312-0	0.375" - 0.500"	0.00025"	0.00015"	2.28"	0.5"	669.81	<b>520.00</b>
52-255-313-0	0.500" - 0.625"	0.00025"	0.00015"	2.44"	0.5"	669.81	<b>520.00</b>
52-255-314-0	0.625" - 0.750"	0.00025"	0.00015"	2.44"	0.75"	686.87	<b>530.00</b>
52-255-315-0	0.750" - 1"	0.00025"	0.00015"	2.60"	0.75"	754.39	<b>585.00</b>
52-255-316-0	1" - 1.375"	0.00025"	0.00015"	2.60"	1.375"	1074.84	<b>835.00</b>
52-255-317-0	1.375" - 2"	0.00025"	0.00015"	3.15"	1.375"	1100.54	<b>855.00</b>
52-255-318-0	2" - 2.625"	0.00025"	0.0002"	3.15"	2.625"	1312.78	<b>1020.00</b>
52-255-319-0	2.625" - 3.250"	0.00025"	0.0002"	3.15"	2.625"	1324.53	<b>1030.00</b>
52-255-320-0	3.250" - 4"	0.00025"	0.0002"	3.94"	3.25"	1652.47	<b>1285.00</b>

## Fowler-Bowers XT-Series Holemike Sets

Order No.	Range	Includes	List Price	Sale Price
52-255-565-0	0.250" - 0.375"	2 heads, 2 handles, 1 ring	\$1606.38	<b>\$1250.00</b>
52-255-665-0	0.375" - 0.750"	3 heads, 3 handles, 2 rings	1829.23	<b>1420.00</b>
52-255-775-0	0.750" - 2"	3 heads, 3 handles, 2 rings	2874.11	<b>2240.00</b>
52-255-885-0	2" - 4"	3 heads, 3 handles, 2 rings	3896.40	<b>3200.00</b>

## Still Using Pin Gages?

### MicroGage

#### 2-Point Small Bore Gaging System



The Fowler-Bowers MicroGage 2-point bore gaging system has been designed specifically for the measurement of small bores between 1.0 - 6.0 mm. The measuring heads are equipped with spherical, split-ball, hard-chromed contact points.

- System range : 0.040" - 0.250"/1 - 6mm
- Switchable resolution 0.0005", 0.0005"/0.01, 0.001, 0.0005mm
- Repeatability : 0.00005"/0.001mm
- Sets include setting rings
- UKAS-certificates as standard with all setting rings
- Depth stops available

Order No.	Description	List Price	Sale Price
54-551-010-0	0.037" - 0.096"/0.95 - 2.45mm	\$3184.87	<b>\$2950.00</b>
54-551-011-0	0.060" - 0.167"/1.5 - 4.25mm	3117.04	<b>2850.00</b>
54-551-012-0	0.089" - 0.250"/2.25 - 6.35mm	3286.21	<b>3010.00</b>
<b>Connectivity Cables</b>			
54-115-526-0	Proximity cable with USB connection	\$138.79	<b>125.00</b>
54-115-527-0	Proximity cable with serial connection	138.79	<b>125.00</b>

Prices & Specifications are subject to change without notice.





# Fowler-Bowers **BLUETOOTH** XTH3 Holematic Pistol Grip Sets



## TABLET!

with Complete Set Purchase!

Watch the Demo!

**You**Tube  
FowlerVid



- Self centering 3 point heads above 0.250"
- USB connectivity and Bluetooth
- Resolution: 0.00005"/0.001mm
- IP67 rated
- To reduce hand fatigue, the travel of the Holematic trigger is adjustable for minimum over travel
- Tungsten carbide measuring faces on all 3-point heads from 0.5" (12.5mm) and up
- Sizes over 0.500" (12.5mm) feature blind bore capability
- Includes UKAS certificates for all pistol grip, heads and rings

"Fowler-Bowers  
makes an awesome  
product!"

T.T.



54-567-050-BT

Contact the Fowler Technical Department for special measuring applications

Order No.	Range	Includes	List Price	Sale Price
54-567-009-BT	0.080" - 0.250"/2 - 6mm (2-point heads)	5 heads, 1 handle, 3 rings	\$6137.32	<b>\$5090.00</b>
54-567-010-BT	0.250" - 0.375"/6 - 10mm	2 heads, 1 handle, 1 ring	2406.45	<b>1995.00</b>
54-567-020-BT	0.375" - 0.750"/10 - 20mm	3 heads, 1 handle, 2 rings	2815.32	<b>2335.00</b>
54-567-050-BT	0.750" - 2" /20 - 50mm	3 heads, 1 handle, 2 rings	3635.16	<b>3015.00</b>
54-567-100-BT	2 - 4"/50 - 100mm	3 heads, 1 handle, 2 rings	4046.12	<b>3355.00</b>
54-567-105-BT	4 - 6"/100 - 150mm	2 heads, 1 handle, 1 ring	3635.16	<b>3015.00</b>
54-567-110-BT	6 - 8" /150 - 200mm	2 heads, 1 handle, 1 ring	4798.32	<b>3980.00</b>
54-567-200-BT	4 - 8" /100 - 200mm	4 heads, 1 handle, 2 rings	7594.92	<b>6300.00</b>
54-567-210-BT	0.750" - 4" /20 - 100mm	6 heads, 1 handle, 4 rings	5915.71	<b>4900.00</b>
54-567-620-BT	0.250" - 0.750" /6 - 20mm	5 heads, 1 handle, 3 rings	3355.29	<b>2780.00</b>
<b>Connectivity Cables/Accessory</b>				
54-115-526-0	Proximity cable with USB connection		\$138.79	<b>\$125.00</b>
54-115-527-0	Proximity cable with serial connection		138.79	<b>125.00</b>
54-115-246-BT	USB bluetooth receiver		49.25	<b>44.00</b>





# Fowler-Bowers **BLUETOOTH** XTD3 Electronic Holemike Sets



## TABLET!

with Complete Set Purchase!



54-367-110-BT

- Self centering 3 point heads above 0.250"
- USB connectivity and Bluetooth
- Resolution: 0.00005"/0.001mm
- IP67 rated
- Ratchet stop for consistent measurement
- Sizes over 1 1/25mm offer extended travel
- Includes UKAS certificates for micrometer, heads and settings rings



Contact the Fowler Technical Department for special measuring applications

Order No.	Range	Includes	List Price	Sale Price
54-367-000-BT	0.080" - 0.250"/2 - 6mm (2-point heads)	5 heads, 1 handle, 3 rings	\$5593.19	<b>\$4640.00</b>
54-367-010-BT	0.250" - 0.375"/6 - 10mm	2 heads, 1 handle, 1 ring	2330.50	<b>1930.00</b>
54-367-020-BT	0.375" - 0.750"/10 - 20mm	3 heads, 1 handle, 2 rings	2780.99	<b>2300.00</b>
54-367-050-BT	0.750" - 2" /20 - 50mm	3 heads, 1 handle, 2 rings	3776.65	<b>3130.00</b>
54-367-100-BT	2 - 4"/50 - 100mm	3 heads, 1 handle, 2 rings	4181.37	<b>3465.00</b>
54-367-105-BT	4 - 6"/100 - 150mm	2 heads, 1 handle, 1 ring	3530.08	<b>2925.00</b>
54-367-110-BT	6 - 8" /150 - 200mm	2 heads, 1 handle, 1 ring	4663.07	<b>3865.00</b>
54-367-200-BT	4 - 8" /100 - 200mm	4 heads, 1 handle, 2 rings	7368.11	<b>6110.00</b>
<b>Connectivity Cables/Accessory</b>				
54-115-526-0	Proximity cable with USB connection		\$138.79	<b>\$125.00</b>
54-115-527-0	Proximity cable with serial connection		138.79	<b>125.00</b>
54-115-246-BT	USB bluetooth receiver		49.25	<b>44.00</b>

Prices & Specifications are subject to change without notice.





# Fowler-Trimos THV Horizontal Measuring System

# Package

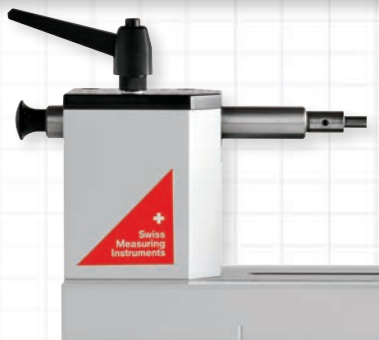

Multiple accessories ensure versatile applications for checking all types of gages such as plug gages, ring gages, thread plug gages, lever dial indicators, etc. as well as precision manufactured parts. Measuring range 2" and application range 4".

High accuracy is guaranteed by perfect instrument construction and the Heidenhain measuring system. The simplicity of the instrument and its ease of use allows precise and quick performance of all measurements. Adjustable Measuring Force is suitable for measuring thread members utilizing the 3 wire method.

## Package 1 *includes..*

		<b>List Price</b>
54-198-558-0	Fowler-Trimos THV w/floating table	\$17,857.32
54-198-115-0	Measuring Table for Plug Gages	5,893.87
54-198-110-0	Display Unit Quadra Check	3,464.53

**Special Package Price**  
**\$22,590.<sup>00</sup>**

**List \$27,215.72**

**The Fowler-Trimos innovative horizontal instrument that fulfills current quality requirements for many applications.**

# Discounts



<b>Specifications:</b>	
Overall Application Range	Using standard probe
External measurement	0 - 4" /0 - 100mm
Internal measurement	.4 - 4" /10 - 100mm
Scale Range (travel)	Absolute display over 2"/50mm
Max. Measuring Band Error	0.000016"/0.4µm reference
Temperature	20°C
Resolution on Heidenhain ND 287	0.00001", 0.000001"
Repeatability	0.000005" ±2s (.1µm)
Adjustable Measuring Force	0 to 12N (0-40 oz.)

## Package 2 *includes..*

		<b>List Price</b>
54-198-508-0	Fowler-Trimos THV w/standard table	\$14,235.27
54-198-115-0	Measuring Table for Plug Gages	5,893.87
54-198-110-0	Display Unit Quadra Check	3,464.53

**Special Package Price**

**\$19,580.<sup>00</sup>**

List \$23,593.67

Fowler® TOOL-A-THON® Vol. 18.3



Find us on social media!

f

e

in

YouTube



# Fowler - Trimos V3, V4 & V5 Electronic Height Gages

The Fowler-Trimos V3, V4 and V5 vertical measuring instruments have been developed for the most difficult workshop environments. Manufactured in their entirety in Switzerland, they guarantee a robust, precise and reliable product in the long run.

- "Black mask" display with user friendly functions
- Electronically adjustable measuring force 0.75/1.5 (N)
- Lithium-ion rechargeable batteries
- All adjustments possible without tools
- Cast iron base for optimal stability
- RS-232 and USB interfaces requires 54-192-112-0 cable
- Dual probe holders (V4 and V5 Only)
- Carriage displacement: Manual  
(V5 includes selectable manual or motorized carriage displacement)
- Measures heights, diameters, perpendicularity, center-lines, Min/Max/Delta
- Resolution: 0.00005"/0.001mm
- Repeatability (2s): 0.00008"/0.002mm (Ø 0.00016"/0.004mm)

#### All V Models Include:

- Charging unit
- Measuring insert with ruby ball Ø4mm
- Probe holder elbow Ø 8mm
- Setting gage
- User's manual and test certificate



54-192-340-0

V3	54-192-340-0	54-192-370-0	
Measuring Range	16"/407mm	28"/711mm	
Range with Probe inverted	20"/508mm	31.9"/812mm	
Max. Permissible Errors	0.00028"/0.007mm	0.00032"/0.008mm	
Frontal Squareness Deviation	0.0004"/0.010mm	0.0006"/0.015mm	
Air Cushion		NO	
V4	54-191-440-0	54-191-470-0	
Measuring Range	16"/407mm	28"/711mm	
Range with Probe inverted	28.3"/719mm	40.2"/1023mm	
Max. Permissible Errors	0.0002"/0.005mm	0.00028"/0.007mm	
Frontal Squareness Deviation	0.0004"/0.010mm	0.0006"/0.015mm	
Air Cushion		YES	
V5	54-199-540-0	54-199-570-0	54-199-590-0
Measuring Range	16"/407mm	28"/711mm	43.7"/1110mm
Range with Probe inverted	28.3"/719mm	40.2"/1023mm	56"/1422mm
Max. Permissible Errors (µm)		2.5 + L(mm)/300	
Frontal Squareness Deviation	0.0002"/0.005mm	0.00032"/0.008mm	0.00043"/0.011mm
Air Cushion		YES	

Order No.	Description
54-192-340-0	V3 Height Gage
54-192-370-0	V3 Height Gage
54-191-440-0	V4 Height Gage
54-191-470-0	V4 Height Gage
54-199-540-0	V5 Height Gage
54-199-570-0	V5 Height Gage
54-199-590-0	V5 Height Gage
<b>Probe Sets</b>	
54-199-105-0	4mm Probe Set, 21 piece
54-199-106-0	8mm Probe Set, 16 piece
54-199-107-0	Economy Probe Set, 7 piece
<b>Accessories</b>	
54-199-400-0	12"/300mm Holder - for 8mm probes
54-199-021-BT	NEW Bluetooth module
54-115-246-BT	Bluetooth receiver
54-777-120-0	Vmux software - for connecting multiple units to one PC



**NEW Bluetooth Module Available!**

*EXTREMELY Easy to Use!*



54-191-440-0



Watch the Demo!

**You Tube**  
**FowlerVid**



54-199-570-0

**NOW**  
available with  
**ISO Cert.**

**Contact the Fowler Sales Department 1-800-788-2353**

Range	List Price	Sale Price
16"/407mm	\$4453.95	<b>\$4100.00</b>
28"/711mm	4910.69	<b>4465.00</b>
16"/407mm	5866.82	<b>5330.00</b>
28"/711mm	6825.02	<b>6200.00</b>
16"/407mm	6466.09	<b>5800.00</b>
28"/711mm	7662.55	<b>6950.00</b>
43"/1100mm	11,853.28	<b>10,700.00</b>
	\$1713.54	<b>\$1500.00</b>
	1278.65	<b>1190.00</b>
	453.90	<b>420.00</b>
	\$959.15	<b>\$890.00</b>
	494.70	<b>460.00</b>
	49.25	<b>44.00</b>
	451.76	<b>411.00</b>

Prices & Specifications are subject to change without notice.

**Fowler** TOOL-A-THON® Vol. 18.3



Find us on social media!

f e in You Tube



# Fowler-Sylvac Hi\_Cal Electronic Height Gages

- Extra low measuring force, from 0.2N
- Measure internal and external diameters, centerlines, heights, widths, depths and MIN/MAX/TIR capability
- Excellent repeatability thanks to the motorized carriage
- High reliability
- Data output USB and RS-232
- Battery life: 40 hours rechargeable during operation
- Touch sensitive probe speed for easy operation
- Base with small footprint
- Includes: protective cover, charging set, ruby ball probe Ø3mm, setting gage and calibration certificate



54-931-150-0

**NOW**  
available with  
**ISO Cert.**

## Accessory Probe Sets



54-930-215-0



Swiss Quality!



54-930-217-0

**FREE** 1mm Ball Probe with

Order No.	Range
54-931-150-0	6"/150mm
54-931-150-C	6"/150mm <i>with ISO/A2LA Certification</i>
54-931-300-0	12"/300mm
54-931-300-C	12"/300mm <i>with ISO/A2LA Certification</i>
54-931-450-0	17.5"/450mm
54-931-450-C	17.5"/450mm <i>with ISO/A2LA Certification</i>
<b>Accessories</b>	
54-930-215-0	Full Probe Accessory Set
54-930-217-0	Basic Probe Accessory Set



Watch the Demo!  
**YouTube**  
**FowlerVid**



**Fowler**  
**TOOL-A-THON® Vol. 18.3**

**FREE Basic Probe Set**  
 with 54-931-450-0 Hi\_Cal Purchase  
**\$605.00 Value!**

6"/150mm & 12"/300mm Hi\_Cal Purchase

Accuracy	List Price	Sale Price
0.00013"/0.0034mm	\$4754.73	<b>\$4250.00</b>
0.00016"/0.0042mm	5464.18	<b>4950.00</b>
0.00020"/0.005mm	5973.56	<b>5350.00</b>
	\$1115.83	<b>\$995.00</b>
	605.51	<b>550.00</b>

Prices & Specifications are subject to change without notice.



Find us on social media!



Fowler TOOL-A-THON® Vol. 18.3

# LIFETIME WARRANTY

We are so confident that these Fowler-Sylvac Mark VI electronic indicators are the most accurate, most dependable, best made products you can buy, we are extending the warranty to last a lifetime!

Quality, accuracy, dependability, world-class customer service and now a real Lifetime Warranty!

*NO Gimmicks  
NO Hurdles  
NO Nonsense*

## Mark VI Electronic Indicators

- Robust construction
- Repeatability: 2µm
- Output: Proximity/Power - USB/RS-232/digimatic/Wireless
- Menus customizable with free software
- Wide range of functions (MIN/MAX/DELTA, TOL, Factor, Preset. Auto Off, etc)
- Bezel rotates 270°
- Large display with LED tolerance indicators
- Includes lug back

**NOW**  
available with  
**ISO Cert.**



Swiss Quality!

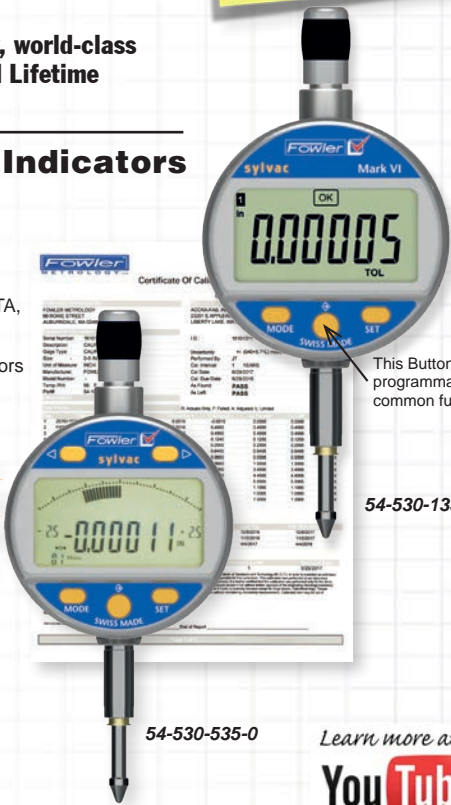

This Button is programmable for common functions

54-530-135-0

54-530-535-0

Learn more at ...



Order No.	Description	Maximum Error	Resolution	List Price	Sale Price
54-530-125-0	0 - 0.500"/12.5mm	0.0004"/0.01mm	0.0005"/0.01mm	\$439.37	<b>\$395.00</b>
54-530-135-0	0 - 0.500"/12.5mm	0.00012"/0.003mm	0.00005"/0.001mm	562.60	<b>499.00</b>
54-530-145-0	0 - 1"/25mm	0.0004"/0.01mm	0.0005"/0.01mm	501.47	<b>450.00</b>
54-530-155-0	0 - 1"/25mm	0.00016"/0.004mm	0.00005"/0.001mm	600.11	<b>540.00</b>
54-530-155-C	0 - 1"/25mm with ISO/A2LA Certification				<b>565.00</b>
54-530-175-0	0 - 2"/50mm	0.00019"/0.005mm	0.00005"/0.001mm	\$1135.91	<b>1015.00</b>
<b>Bluetooth</b>					
54-530-335-0	0 - 0.500"/12.5mm	0.00012"/0.003mm	0.00005"/0.001mm	\$696.55	<b>\$620.00</b>
54-530-355-0	0 - 1"/25mm	0.00016"/0.004mm	0.00005"/0.001mm	744.82	<b>665.00</b>
<b>Accessory</b>					
54-115-246-BT	USB Bluetooth Receiver			\$49.25	<b>\$44.00</b>
<b>Analog Display</b>					
54-530-535-0	0 - 0.500"/12.5mm	0.00012"/0.003mm	0.00005"/0.001mm	\$632.25	<b>\$565.00</b>
54-530-555-0	0 - 1.00"/25mm	0.00016"/0.004mm	0.00005"/0.001mm	691.24	<b>615.00</b>



# Premium Dial Indicators

- Tolerance markers
- Solid steel housing
- Carbide contact point

"Great price for a great indicator" V.C.



### Calibration Certificate

52-520-110-1 Tool Description: Dial Indicator  
 Range: 1"  
 ASME B89 Tool Resolution: .001"  
 10°C Humidity: 50%  
 Pass Function Inspection: Pass

### Measurements

Item	Nominal Size	+/- Tolerance	+/- Deviation	Pass/Fail
1	10"	.001"	0	P
2	20"	.001"	0	P
3	30"	.002"	0	P
4	40"	.002"	0	P
5	50"	.002"	0	P
6	60"	.002"	+ .001	P
7	70"	.002"	+ .001	P
8	80"	.002"	0	P
9	90"	.002"	0	P
10	100"	.002"	0	P

Reference used: Gage Block

Test Uncertainty: .0001mm

Calibration Date: 01/15/15

Inspector: [Signature]

Purchase/Activation Date: 01/15/15

Fowler Precision - 66 Rowe St  
 Home: (908) 233-1030

**3 year Warranty**

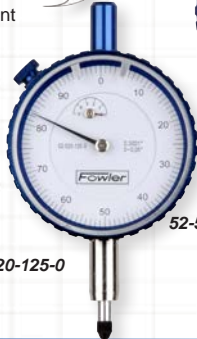

52-520-125-0



52-520-110-2

**Includes NIST Certificate of Calibration**

Order No.	Range	Graduation	Reading	Balanced Reading	Dial Color	List Price	Sale Price
52-520-110-2	1"	0.001"	0 - 100	—	White Face	\$91.09	<b>\$60.00</b>
52-520-129-0	1"	0.0005"	0 - 50	0 - 25 - 0	White Face	110.16	<b>74.00</b>
52-520-125-0	0.250"	0.0005"	0 - 50	0 - 25 - 0	White Face	120.24	<b>81.00</b>
52-520-500-0	25mm	0.01mm	0 - 100	0 - 50 - 0	White Face	138.67	<b>94.00</b>

## DUAL PLUS+ Dial Indicator

- Two dial indicators in one
- Inch on one side and metric on the opposite side
- Range: 0.5"/12.5mm
- Graduation: 0.001"/0.01mm
- 8mm mounting stem with 3/8" adaptor bushing included
- Jeweled movements
- Carbide contact point
- 1" spline contact point included
- Includes NIST certificate for both inch and metric readings

**NEW!**

Inch Reading Side



Metric Reading Side



Order No. 52-530-115-0

**Sale \$95.00**

List \$107.10

Fowler TOOL-A-THON® Vol. 18.3



Find us on social media!

f E in You

# INDI-X<sup>blue</sup>

## Electronic Indicators

INCH • METRIC • FRACTION™

- 2-1/4" dial face
- Lugback and 3/8" stem mountings
- Resolution 0.0005"/0.01mm
- Tolerance function
- Absolute/incremental reading
- Floating zero

54-520-250-0

54-520-260-0



**Carbide-tipped point!**



"Easy to use, easy to read, top notch accuracy"  
Mr. R.

Order No.	Description	List Price	Sale Price
54-520-255-0	0.50"/12.5mm Indi-X Blue	\$101.06	<b>\$70.00</b>
54-520-250-0	1"/25mm Indi-X Blue	108.81	<b>75.00</b>
54-520-260-0	1"/25mm/64ths Indi-X Blue Inch-Metric-Fraction	110.40	<b>80.00</b>

# HOLDXTEC® Holding Systems

- All accept 3/8" indicators
- Mag base and HOLD-TEC with fine adjust also accepts 8mm indicators
- All have dovetail clamps for test indicators
- Mag base features 2 fine adjusts making it a **6-Axis Mag Base**
- HOLD-TEC can be mounted in drill chucks, collets, dial gage stands with 8mm mount diameter to make a quick transfer stand
- Mag base has 180 lb. pull
- Adjust to any position
- Powerful On/Off mag base
- Central locking system

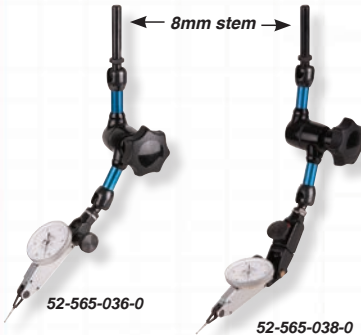

Order No.	Description	List Price	Sale Price
52-585-085-0	HOLD-Tec Mag Base with Double Fine Adjust	\$162.57	<b>\$95.00</b>
52-565-036-0	HOLD-Tec without Fine Adjust	91.31	<b>62.00</b>
52-565-038-0	HOLD-Tec with Fine Adjust	99.24	<b>65.00</b>

## Indicator & Mini Mag Set

- AGD group 1 indicator
- 0.250" range
- 0.001" graduations, 0-100 reading
- Tolerance markers
- Carbide contact point
- Mag base with fine adjust (also accepts test indicators with dovetails), base measures 1.8" x 1.2"
- On/off switch for secure holding and easy removal
- 37 lbs. of magnetic pull
- 22 piece contact point set — flat, radius, cone and spline type contacts
- Fitted aluminum case

### Super Deal!

Order No. 52-585-310-0

# Sale \$60.00

List \$189.35



## Articulating Mag Base

Can be set up in almost unlimited positions!



Order No. 52-585-008-0

# Sale \$75.00

List \$103.65

- Adjust in almost unlimited ways
- Fine adjust
- 85 lb. pull
- V-slot on base for mounting on rounded surfaces

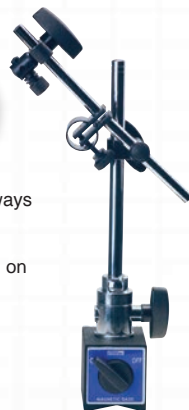

## Flex Arm Mag Base

- Corrosion resistant chrome plated flex arm
- 85 lb pull magnetic base
- Base can be mounted vertically as well as horizontally
- V-bottom base allows mounting on cylindrical surfaces
- Adjusts to virtually any position

Order No. 52-585-045-0

# Sale \$75.00

List \$101.17



Fowler® TOOL-A-THON® Vol. 18.3



Find us on social media!

f

e

in

YouTube

# XTEST

## Horizontal Indicators

- Solid copper body
- Super smooth jeweled movement
- Smoother bezel adjustment for easier zero setting
- 0.080" and 0.120" carbide ball contact points (0.040" steel ball)
- 0.060" range with auto reverse and rev. counter
- Easy to read tilted dial
- 5/32" pivotable stem



52-562-001-0

52-562-002-0

**Includes NIST Certificate of Calibration**

Order No.	Style	Graduations	Dial Diameter	Dial Reading	List Price	Sale Price
52-562-001-0	Horizontal	0.0005"	1-1/2"	0-15-0	\$129.76	<b>\$99.00</b>
52-562-002-0	Horizontal	0.0005"	1"	0-15-0	129.76	<b>99.00</b>

# XTEST Vertical Indicator

**TWICE** the range of most indicators!

- Graduations: 0.0005"
- Dial diameter: 1" and dial reading: 0 - 15 - 0
- Solid copper body and super smooth jeweled movement
- Smoother bezel adjustment for easier zero setting
- 0.080" and 0.120" carbide ball contact points (0.040" steel ball)
- 0.060" range with auto reverse and rev. counter
- 5/32" pivotable stem



**Includes NIST Certificate of Calibration**

Order No. 52-562-005-0

**Sale \$99.00**

List \$142.10



## Test Indicators

All Fowler Test Indicators include bi-directional constant clockwise rotation, automatic reversal, three dovetail mountings, jeweled movement, two dovetail clamps and a molded case.



52-562-776-0



52-562-780-0



Order No.	Face Color	Total Range	Dial Reading	Graduation	Dial Diameter	Point Length	List Price	Sale Price
52-562-776-0	white	0.030"	0-15-0	0.0005"	1-1/2"	1/2"	\$135.57	<b>\$80.00</b>
52-562-780-0	black	0.030"	0-15-0	0.0005"	1-1/2"	1/2"	135.57	<b>80.00</b>



# XTENDER 1.4" to 6" Dial Bore Gage Sets with Carbide Anvils

Industry's two most popular bore gage ranges combined in one set!

### Carbide Anvils

- Easy-to-read
- Graduation: 0.0005" or 0.01mm
- Insulated grip
- 1.4" to 6" range or 35 to 160mm



52-646-400-0

Order No.	Range	Graduation	List Price	Sale Price
52-646-400-0	1.4 - 6"	0.0005"	\$192.89	<b>\$140.00</b>
52-646-500-0	1.4 - 6"	0.0001"	241.72	<b>180.00</b>

# XTENDER-E 1.4" to 6" Dial Bore Gage Set with Carbide Anvils

Industry's two most popular bore gage ranges combined in one easy-to-use electronic set!

Preset size of master for absolute reading and use minimum hold feature to lock on the bore size as the gage is rocked in the part to be measured.



### Bore Gage Features:

- Range: 1.4"-6"/35mm-150mm
- Carbide anvils
- Self-centering

### Indicator Features:

- Bar graph and numeric digital display
- Resolution: 0.00005"/0.001mm
- Preset with recall
- ABS/INC measurement
- Min/Max/TIR

"Excellent quality, well built."

Lee C.



Learn more at...  
**YouTube**  
FowlerVid

Order No. 54-646-401-0

**Sale \$255.00**

List \$333.27

# XTENDER-E PLUS+ Bore Gage Set



- Range: 1.4 - 6"
- Fitted with a Sylvac lifetime warranty electronic indicator (54-530-535-0)
- Analog scale for reversal point detection
- IP54 rated indicator
- Carbide tipped anvils
- Resolution: 0.00005"/0.001mm
- Min/Max/TIR readings
- Supplied in a fitted case



Order No. 54-646-535-0

**Sale \$705.00**

List \$785.00



Find us on social media!  
Facebook  
Twitter  
LinkedIn  
YouTube



## 2" to 6" Right Angle Dial Bore Gage

For measuring difficult-to-reach bores in tight or inconveniently located spaces on machine applications.

- Carbide anvils
- Easy-to-read
- Economical
- Range: 2" to 6"
- Graduation: 0.0005"
- Insulated grip



Order No. 52-646-250-0

**Sale \$210.00** List \$285.59

## Bore Gage Setting Master Kits - Inch & Metric

Fowler's Bore Gage Setting Master Kit is used for accurately setting any bore gage up to 6"/150mm in diameter to an accuracy of 0.0001"/0.003mm

### Each Set includes:

#### Setting Device (53-646-000-1 - Inch Model)

- Base anvil: 3.950" x 1.050"
- Adjustable anvil 2.375" x .375" (two each)
- Internal capacity: 6"/150mm
- Depth capacity: 1"/25mm
- Centralizer capacity width: 2.750"
- Quick-release holder for fast adjustment
- **Can also be used for external setting, depending on application (external mics, snap gages, caliper gages)**

#### Economy Gage Block Sets

##### Inch model:

- 36 piece
- Tolerances to .00005"
- Certificate of Calibration to NIST

##### Metric model:

- 33 piece
- AS-2 grade
- Certificate of Calibration to NIST



**Includes:**  
Bore gage setting master and gage block set.  
All in a custom-fitted case!

53-646-000-1

Order No.	Description	List Price	Sale Price
53-646-000-1	Inch Bore Gage Setting Master Kit	\$309.49	<b>\$225.00</b>
53-646-010-0	Metric Bore Gage Setting Master Kit	322.50	<b>235.00</b>
53-646-005-0	Bore Gage Setting Master Kit - <b>without</b> Gage Blocks	178.50	<b>160.00</b>

# Z-HEIGHT ABS PLUS+

- **NEW** true ABS measuring system
- **Supplied with a NIST certified test block (1" x 2" x 3")**
- Supplied with mini USB data cable
- Heavy duty single column design
- Carbide scriber
- Ground and lapped base for smooth movement
- Steel rack with large hand wheel for coarse and fine adjustment
- Positive locking level for scriber
- Can be used with wireless transmitter (54-115-100-0)

**NEW!**



54-175-012-1

Order No.	Range	Accuracy	List Price	Sale Price
54-175-012-1	<b>NEW</b> 12"/300mm	± 0.0016"/0.04mm	\$589.98	<b>\$530.00</b>
54-175-018-1	<b>NEW</b> 18"/500mm	± 0.002"/0.05mm	695.00	<b>625.00</b>
54-175-024-1	<b>NEW</b> 24"/600mm	± 0.002"/0.05mm	798.00	<b>710.00</b>
<b>Accessory</b>				
54-115-100-0	Wireless transmitter		\$108.59	<b>\$99.00</b>

## Twin Beam Dial Height Gages

- Separate digit counters register both upward & downward travel
- Zero setting can be obtained throughout the gage's range
- Coarse readings in 0.100" graduations; fine readings taken on indicator are 0.001"
- Dual chrome plated beams
- Carbide-tipped scriber.
- Base is hardened, ground & lapped for maximum flatness
- Accuracy for 12": ± 0.0015"
- Accuracy for 24": ± 0.002"

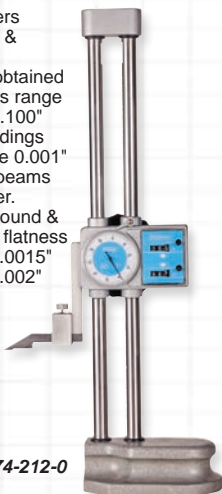

52-174-212-0

Order No.	Range	List Price	Sale Price
52-174-212-0	12"	\$290.70	<b>\$215.00</b>
52-174-224-0	24"	484.50	<b>405.00</b>

## Twin Beam Electronic Height Gages with Offset Scriber

- Measuring range: 0 - 12"/0 - 300mm
- Accuracy: ± 0.002"/0.05mm
- Carriage design with offset scriber holder
- Base is ground and lapped for flatness
- Handwheel provides coarse and fine movement
- Updated electronic and mechanical design offers better accuracy and movement of carriage
- Carbide tipped scriber
- Functions include pre-set, in/mm conversion and ABS/INC for direct or comparative measuring



Order No. 54-174-224-3

**Sale \$595.00**  
List \$678.30

Fowler  
TOOL-A-THON® Vol. 18.3



Find us on social media!  





# Digi Level PLUS+



- Super large 18mm backlit display
- Bluetooth model available
- Includes a 6" graduated, beveled straight edge PLUS, [see page 41](#)
- Rechargeable battery
- USB charging cable supplied
- V's on top and bottom for measuring on cylindrical surfaces
- Embedded magnets on bottom base
- IP65 rated
- Auto inverting display



54-422-550-0

Order No.	Description	List Price	Sale Price
54-422-550-0	<b>NEW</b> Digi-Level PLUS	\$123.05	<b>\$110.00</b>
54-422-550-BT	<b>NEW</b> Digi-Level PLUS with Bluetooth	139.10	<b>125.00</b>

## mini-MAG Protractor™

The mini-MAG Protractor provides instant 360° digital inclination display of any angle with the additional unique feature of embedded magnets on both sides and the bottom which make it ideal for a variety of measurements.

- Embedded magnets with 3.5lb. pull
- Uses standard 9V battery (250 hrs.)
- Measuring range: 360° (4 x 90°)
- Display automatically inverts
- Resolution: 0.05°
- Accuracy: ± 0.2°
- Repeatability: 0.05°
- Dimensions 2.375" x 1.375" x 2.375"
- Hold feature



Display inverts for easy reading!

Order No. 54-422-450-1

**Sale \$55.00**

List \$103.65



## Combination Square

- Blades are chrome plated, fully hardened and tempered
- Includes square, protractor and center head with 12" blade
- Square head has level and scribe point
- Double indexed protractor is graduated 180° in both directions
- Graduated in 8ths, 16ths, 32nds and 64ths

"Good instrument, good price."

R.L.



Order No. 52-370-012-0

**Sale \$164.00**

List \$208.68



# Steel Squares & Sets



52-432-246-0

- Made of the finest carbon tool steel, these economy squares have true right angles both inside and outside
- Beams and blades ground and lapped for straightness and parallelism
- Hardened blade
- Beam grooved at inner corner for clearance of burrs and dirt
- Squareness of blade edge to the working face: 2" & 3" =  $\pm 0.0006"$ , 4" & 6" =  $\pm 0.0008"$ , 9" & 12" =  $\pm 0.0012"$

Sets come complete in a "Shop Hardened" molded case!

Blade Size	Beam Size
2"	1.5"
3"	2.5"
4"	3"
6"	4"
9"	6"
12"	8"

Order No.	Size/Description	List Price	Sale Price
52-432-444-0	3 Piece Square Set: 2", 4" & 6" with shop hardened case	\$73.54	<b>\$64.00</b>
52-432-246-0	4 Piece Square Set: 2", 3", 4" & 6" with shop hardened case	87.61	<b>75.00</b>
52-432-469-0	4 Piece Square Set: 4", 6", 9" & 12" with shop hardened case	172.58	<b>150.00</b>
52-432-004-0	4" Square only	23.04	<b>19.00</b>
52-432-006-0	6" Square only	25.61	<b>22.00</b>
52-432-009-0	9" Square only	58.95	<b>50.00</b>

## Cylindrical Squares

- Used for checking squares, height gages and other instruments
- Hardened and the ends are lapped to 90° angular accuracy
- 6" cylindrical squares:  $\pm 0.0001"$
- 12" cylindrical square:  $\pm 0.00015"$
- Includes handles and wood case

52-750-012-0

52-750-006-0



Order No.	Description	List Price	Sale Price
52-750-006-0	6" cylindrical square	\$196.97	<b>\$162.00</b>
52-750-012-0	12" cylindrical square	281.31	<b>235.00</b>

## Straight Edges

PLUS+

**NEW!**



52-480-070-0

- Hardened steel
- Satin chrome finish on scale
- Beveled edge with 1/64th graduations
- 0.21" thick, 1.59" wide
- Storage sleeve included

Order No.	Description	Straightness	List Price	Sale Price
52-480-065-0	6"	0.0015"	\$22.47	<b>\$19.00</b>
52-480-070-0	8"	0.0015"	27.82	<b>24.00</b>
52-480-075-0	12"	0.0015"	40.66	<b>35.00</b>
52-480-080-0	24"	0.0025"	62.06	<b>53.00</b>



# COAX-2D 2 Dimensional Coaxial Indicator Sets

Use the 2D Coaxial Set for accurate component centering and positioning in most machining applications. The dial remains stationary during the rotation of the machine spindle.

- Indicator assembly with 1.6" (42.5mm) diameter dial
- Graduations and revolution counter 0.0005" (.01mm)
- 3 Internal and 3 External feelers
- Center point feeler
- Restraining arm

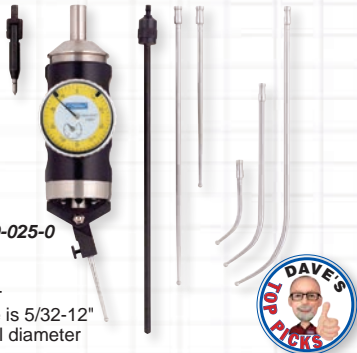

52-710-025-0



### Specifications:

- Length: 6-7/8" (175mm)
- Shank: 3/8" dia. x 7/8" (10mm x 20mm) long
- Feeler ball: 1/8" (3mm) dia.
- Dial readings: 0-50
- Measuring range: 0.250" (6mm) axis offset
- Speed—recommended not to exceed approx. 800 RPM
- Repeatability to within 0.0002" (0.005mm) of true center
- Capacity depends on feelers installed, but overall range is 5/32-12" (4-300mm) internal diameter; 0-12" (0-300mm) external diameter

Order No.	Description	List Price	Sale Price
52-710-025-0	2D Coaxial Set-Inch	\$248.65	<b>\$185.00</b>
52-710-030-0	2D Coaxial Set-Metric	253.51	<b>195.00</b>

## Electronic Edge Finders

- Six equally spaced light ports provide visibility at any angle
- Made in the USA
- Edge finder lights instantly when stylus touches work edge
- Repeatability: 0.0002"
- Works on any conductive metal



54-575-625-0

54-575-650-0



Learn more at ...  
**YouTube**  
**FowlerVid**

Along with light indication, model #54-575-650-0 emits an audible "beep" at time of contact.

Order No.	Stylus	Shank	Audible	Battery	List Price	Sale Price
54-575-625-0	0.200"	1/2"	NO	12 volt	135.80	<b>112.00</b>
54-575-650-0	0.400"	3/4"	YES	12 volt	135.80	<b>112.00</b>

## Fowler/Mirage Tool Set

patent pending

The Fowler/Mirage Tool Set is an easy and affordable way to set Z depths quickly and accurately!

- Can be operated directly off table or from machine vise
- Aluminum contact face eliminates carbide chipping on cutting tools
- Works on any conductive materials
- Repeatability: .0002"
- Block dimensions: 1" x 2" x 3" (nominal)
- Batteries included



Slowly lower cutting tool toward Tool Set...

...Indicator will light up upon contact!

Order No. 54-575-750-0

**Sale \$75.00**

List \$103.92

# QUICK CHECK *Multi-Function Check Standard*



- One compact, multi-function, precise standard
- Can be used to check and verify a multitude of measuring instruments
- Check height gages, calipers, micrometers, depth gages, bore gages, test and dial indicators, caliper gages, protractors, and more ...
- Supplied with a manufacturer's test certificate and fitted wood case
- All sizes marked are actual

Order No. 53-813-015-0

**Sale \$1320.00**

List \$1644.60

## **X-TENDED RANGE** <sup>®</sup> **Pin Gage Sets** *Minus and Plus Tolerances*

Ideal for checking hole size, location, gage slots, distance between holes, go/no-go gaging and setting other gages and micrometers.



- Class ZZ
- Black oxide finish offers extra protection against corrosion and rust, promotes longer life, and highlights wear trends that enables calibration to be performed more effectively
- 240 pcs
- Range: 0.011" - 0.250" in .001" increments.
- Set includes 2 handles and our X-Glide all purpose teflon lubricant
- Certificate of accuracy traceable to N.I.S.T. and registered ISO 9001

**Two ranges  
in one set!**

0.011" - 0.060" & 0.061" - 0.250"

53-880-823-0

Order No.	Description	Accuracy	List Price	Sale Price
53-880-823-0	Plus Pin Gage Set	+0.0002", -0.0000"	\$251.30	<b>\$150.00</b>
53-880-833-0	Minus Pin Gage Set	+0.0000", -0.0002"	251.30	<b>150.00</b>

Prices & Specifications are subject to change without notice.

43



# SHOP-BLOX®

## Rectangular Gage Block Set



"Perfect for small shops. A really great bang for the buck"

M.L.L.



- Manufactured to meet Federal Specification ASME B89. 1.9 - 2002 tolerances on length for inch gage blocks
- 81 pieces
- Certificate of Calibration traceable to NIST
- Tolerances to  $\pm 0.00005"$
- In high-quality fitted wood case

Order No. 53-672-081-0

**Sale \$390.00**

List \$539.39

## Grade Ø Rectangular Steel Gage Block Sets

- Grade Ø
- Each block certified to N.I.S.T.
- Each block is individually serialized
- Sizes clearly marked on each block
- Complete with fitted wooden case

53-670-038-0



Order No.	Description	List Price	Sale Price
53-670-038-0	36 piece Grade Ø Rectangular Gage Block Set	\$479.66	<b>\$355.00</b>
53-670-080-0	81 piece Grade Ø Rectangular Gage Block Set	882.69	<b>645.00</b>

## Large Square Gage Blocks

- Grade Ø
- NIST Traceable
- Vertically more stable than rectangular blocks
- Large sizes help eliminate block stacks
- Meets or exceeds Federal Specifications ASME B89.1.9-2002

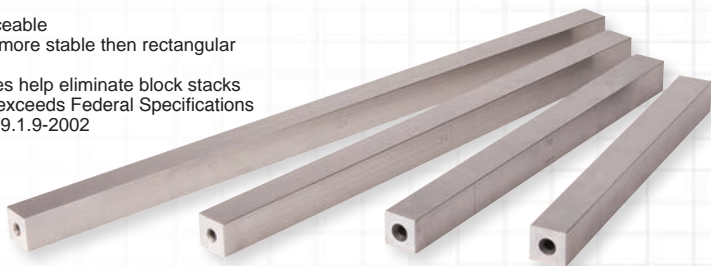

Order No.	Description	List Price	Sale Price
53-676-216-0	5" Large Square Gage Block	\$235.20	<b>\$188.00</b>
53-676-218-0	6" Large Square Gage Block	282.40	<b>225.00</b>
53-676-220-0	7" Large Square Gage Block	324.01	<b>258.00</b>
53-676-222-0	8" Large Square Gage Block	382.56	<b>305.00</b>
53-676-224-0	10" Large Square Gage Block	532.23	<b>425.00</b>
53-676-226-0	12" Large Square Gage Block	591.88	<b>470.00</b>
53-676-228-0	16" Large Square Gage Block	888.91	<b>710.00</b>
53-676-230-0	20" Large Square Gage Block	1036.27	<b>825.00</b>



# Rules

52-297-006-0

## EZ-Read Black Face Rules

- Hardened stainless steel
- White easy-to-read microfine graduations against a black, non-glare finish

52-330-006-0

## Satin Chrome Rules

- Tempered steel
- Non-glare
- Sharp, easy-to-read microfine graduations



**GRADUATIONS**  
**4R:** 8ths, 16ths, 32nds, 64ths  
**16R:** 32nds, 64ths, 50ths, 100ths

### RIGID STEEL RULES

Order No.	Finish	Size	Reading	List Price	Sale Price
52-330-006-0	Satin Chrome	6"	4R	\$14.18	<b>\$12.00</b>
52-337-006-0	Black	6"	4R	11.32	<b>10.00</b>
52-330-012-0	Satin Chrome	12"	4R	24.28	<b>21.00</b>
52-337-012-0	Black	12"	4R	21.83	<b>18.00</b>
52-350-006-0	Satin Chrome	6"	16R	11.93	<b>10.00</b>
52-338-006-0	Black	6"	16R	11.32	<b>10.00</b>
52-350-012-0	Satin Chrome	12"	16R	24.13	<b>19.00</b>
52-338-012-0	Black	12"	16R	19.28	<b>15.00</b>

### FLEXIBLE STEEL RULES

Order No.	Finish	Size	Reading	List Price	Sale Price
52-295-006-0	Satin Chrome	6"	4R	\$11.75	<b>\$10.00</b>
52-297-006-0	Black	6"	4R	10.61	<b>9.00</b>
52-295-012-0	Satin Chrome	12"	4R	21.23	<b>18.00</b>
52-297-012-0	Black	12"	4R	17.14	<b>15.00</b>
52-308-006-0	Black	6"	16R	10.30	<b>9.00</b>
52-310-006-0	Satin Chrome	6"	16R	12.14	<b>10.00</b>
52-308-012-0	Black	12"	16R	17.14	<b>15.00</b>
52-310-012-0	Satin Chrome	12"	16R	21.52	<b>19.00</b>

## 6"/150mm Pocket Steel Rule



- Rounded edge prevents damage to shirt pocket
- Rule width: 0.470"
- Inch graduations are in 64ths
- Rule thickness: 0.021"
- Metric scale is in 1mm increments



Order No. 52-380-100-0

**Sale \$6.50**

List \$7.72

## Carbide Super Scriber



- Lightweight
- Retractable carbide tip
- Knurled grip
- Machined aluminum body
- Pocket clip

Order No.	Description	Overall Length	List Price	Sale Price
52-500-050-0	Carbide Super Scriber	6.5"	\$34.96	<b>\$28.00</b>
52-500-055-0	Carbide Refill		10.71	<b>9.00</b>

Prices & Specifications are subject to change without notice.





## 1-2-3 & 2-3-4 Blocks

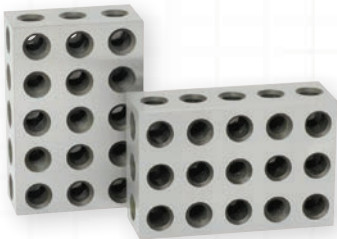

52-439-234-0



- 23 holes for easy clamping
- Sold in pairs
- Hardened 56 - 60 HRC
- Useful in layout & grinding work

Order No.	Description	Accuracy	List Price	Sale Price
52-439-031-0	1-2-3 Blocks	± 0.0002"/1"	\$93.33	<b>\$62.00</b>
52-439-234-0	<b>NEW</b> 2-3-4 Blocks	± 0.0001"/1"	95.00	<b>85.00</b>

## Premium 1-2-3 Block Set

- Hardened (HRC 55 - 60)
- 23 holes for easy clamping, 5 tapped, 18 untapped thru holes
- Complete in a shop-hardened case.
- Surface finish: 6-16μ"
- Includes hex wrench and 5 mounting bolts (3/8"-16)



*"Great product. Every machinist should have a set in their box"*  
D.S.



Learn more at ....



Order No. 52-439-032-0

**Sale \$72.00**

List \$84.79

## 1/8" Parallel Set

- Parallel within 0.0008" each pair
- 6" in length x 0.125" thick
- Heights matched within ± 0.001" each pair
- Heights: 1/2", 5/8", 3/4", 7/8", 1", 1-1/8", 1-1/4", 1-3/8", 1-1/2", & 1-5/8"



Order No. 52-437-000-0

**Sale \$170.00**

List \$238.26

# X-BLOX® V-Block Set



2 each @:

- Dimensions: 1-1/2" L x 1-1/4" W x 1-1/4" H
- Work capacity: Approximately 1"

2 each @:

- Dimensions: 2" L x 1-1/2" W x 1-1/2" H
- Work capacity: 1-1/2"



All feature:

- Surfaces are square and parallel within 0.0005"
- V-grooves are square and parallel with all surfaces within 0.0005"
- Corresponding dimensions for each pair are alike within 0.0005"

Order No. 52-475-500-0

"You will not go wrong buying this product"

J.B

**Sale \$118.00**

List \$133.70

## Telescoping Gage Sets

Another great tool for easy and accurate measurements. Under spring tension, the plungers of the gage expand from the center to the size of the hole being measured and are then locked in place using the knurled knob. Final hole size is obtained by measuring over the contacts with a micrometer or vernier caliper.

- Contact points are constructed of hardened tool steel, precision ground.
- Double action rigid handle with self-centering feature for quick checking of inside measurements
- Constant spring tension for uniform feel
- 52-470-006-0 covers a measuring range of 5/16" to 6"
- with measurable depths of 4" to 5"
- Includes fitted vinyl case

52-470-006-0



52-470-000-0

Order No.	Description	List Price	Sale Price
52-470-006-0	6" Telescoping Gage Set	\$108.04	<b>\$75.00</b>
52-470-000-0	Titanium coated 6" Telescoping Gage Set	121.30	<b>95.00</b>

## Thickness Gage

- Each leaf of the thickness gage made of fine tempered steel, hardened
- Tapered Thickness Gages-Inch.26 Leaf Set: 0.0015", 0.002", 0.0025", 0.003", 0.004", 0.005", 0.006", 0.007", 0.008", 0.009", 0.010", 0.011", 0.012", 0.013", 0.014", 0.015", 0.016", 0.017", 0.018", 0.019", 0.020", 0.021", 0.022", 0.023", 0.024", and 0.025". Length: 3"
- The exact thickness is marked on each leaf
- Steel case with lock nut
- Meets U.S. Federal Specifications

Order No. 52-485-006-0



**Sale \$18.00**

List \$21.96



## Transfer Punch Sets

- Punches are made of hardened and tempered tool steel, black oxide finished
- All sizes are marked and diameters are slightly undersized for easy handling
- Set supplied with index stand



52-482-028-0



52-482-030-0

Order No.	Description	Range	List Price	Sale Price
52-482-028-0	28 pc. Transfer Punch Set	3/32" to 1/2"	\$53.48	<b>\$35.00</b>
52-482-030-0	33 pc. Transfer Punch Set	1/2" to 1"	92.96	<b>75.00</b>

## XTRA-PUNCH Heavy Duty Transfer Punch Set

- 1/2" - 1" range in 1/64"
- 36 piece set, 3 master punches and 33 individually sized sleeves
- Simply select the laser etched sleeve for the size required, place it on one of the master punches for that range and it is ready to use
- Punch tips are hardened 48-55 HRC
- Master punches are 4-7/8" in length and sleeves are 1" in length
- 1/4" the weight of a conventional transfer punch set



Order No. 52-482-040-0

**Sale \$79.00**

List \$92.31

## Bell Punch

- Easily locates and allows center punching of ends on round stock up to 1.4"
- Hardened to 48-52 HRC
- Accurate to 0.0016"/0.04mm



Order No.	Description	List Price	Sale Price
52-500-150-0	Bell Punch	\$21.42	<b>\$14.00</b>
52-500-155-0	Replacement punch	4.59	<b>3.00</b>

## Drive Pin Punch Sets

- Housing finished in black nitrate. Made of chrome alloy steel. Hardened on both ends.
- Knurled finger grip for easy handling
- Length is 4"
- Includes fitted case



52-500-200-0

Order No.	Description	Point Sizes	List Price	Sale Price
52-500-200-0	4 Drive Pin Punch Set	3/16", 7/32", 1/4" & 5/16"	\$13.53	<b>\$6.50</b>
52-500-255-0	8 Drive Pin Punch Set	1/16", 3/32", 1/8", 5/32", 3/16", 7/32", 1/4" & 5/16"	19.16	<b>12.00</b>



## On-Mark Optical Center Punch

Place the acrylic lens in the holder to easily and accurately site in the area on the workpiece to be punched. Replace the lens with the center punch and quickly and accurately mark the workpiece.

- Efficient and precision punching of hole centers
- Magnified center dot and circle for accurate punching
- Used for marking, punching, stoking and riveting
- 9x acrylic lens

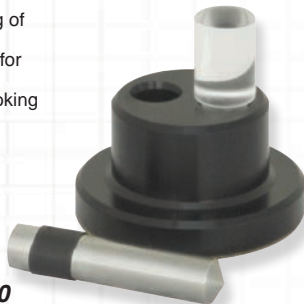

Order No. 52-500-075-0

**Sale \$70.00**

List \$89.47

## Rapid Burr

- "Quick-change" thumb operated button for instant removal, insertion and locking of new blades
- Supplied with a blade for steel and aluminum
- Unique rounded head blade for safe deburring of drilled and machined holes, end milled areas, tubing, backside of holes and an almost unlimited amount of uses
- Curved blades swivel freely to automatically follow shapes, contours and holes
- Adapts to all S-blades
- Molded to comfortably fit the user's hand without slippage or fatigue



Order No. 52-483-025-0

**Sale \$5.00**

List \$7.18

## Universal Deburring, Cleaning & Countersink Set A complete kit for Machine Shop Applications!

### Set includes:

- 1 Universal Handle
- 2 Adapters
- 2 Deburring Blades
- 1 Countersink for 12mm/.47" diameter
- 1 Countersink for 20mm/1.18" diameter
- 4 Cleaner Blades, for sheet metal, small ridges, relieving corners and for narrow slots
- Combined in a compact molded case



Order No. 52-483-888-0

**Sale \$45.00**

List \$62.31

Fowler®

TOOL-A-THON® Vol. 18.3



Find us on social media!





# Year End

## SUPER SALE

Anything on this page

**\$20.00**

Limited  
Quantities

### Dial Indicator

- AGD Group 2
- Range: 0.250"
- 0.001" graduations
- Shockproof ultra smooth gearing
- 0-100 reading
- Revolution counter
- Center lug back
- Tolerance markers
- Carbide ball contact point
- 3/8" mounting stem
- Bezel lock for easy zero setting

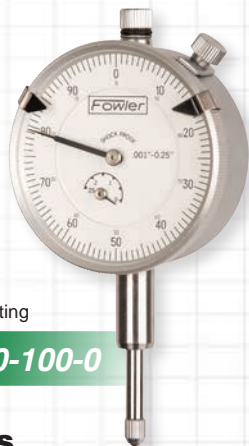

Order No. 52-520-100-0

### Extended Range Point Micrometers



**Twin  
Conical Anvils!**

52-234-522-0

#### Inch/Metric

- Fast, easy-to-read digit counter
- Range: 0.3" - 1.7"/7 - 45mm
- Digital counter reads 0.001"/0.01mm sleeve reads 0.0001"/0.01mm
- Ratchet thimble
- Carbide tipped measuring faces
- Includes case and setting standard

Order No. 52-234-522-0 — Inch  
52-234-523-0 — Metric

Limited  
Quantities

# Year End SUPER SALE

Anything on this page

**\$25.00**

## TAP-X

### Cam-Locking Tap Wrench

**QUICK RELEASE CAM!**

**FAST & TIGHT!**

**CHANGE TAPS FAST!**

- Fits wide range of tap sizes: 1/8" to 1/2" (M3 to M12)
- Patented Revolutionary Cam-Lock System
- Quick-action clamping for easy replacement
- Taps will never release during use
- Heavy-duty design for reliability and long life
- Handles extreme torque
- Can be used as a hand drill for sizes: 1/16" to 5/16"



Check us out!  
**YouTube**  
FowlerVid

Limited  
Quantities

Order No. 52-492-350-0

## XTRA-VALUE

### Depth Gage

INCH • METRIC • FRACTION™



- Spring-loaded and hold measurement button for ease-of-use
- Super-large display
- Travel: 0 - 1"/25mm
- Range: 0 - 2"/50mm
- Resolution: 0.0005"/.01mm (Fractions in 1/64" increments)
- Includes 1" extension

Limited  
Quantities

Order No. 54-225-555-S

Fowler® TOOL-A-THON® Vol. 18.3



Find us on social media!

f

e

in

YouTube



HIGH PRECISION  
[www.fowlerprecision.com](http://www.fowlerprecision.com)